



IDEAL FOR
RECESSED
INSTALLS

BT8331

UNIVERSAL POP-IN, POP-OUT MENU BOARD MOUNTING SYSTEM



The BT8331 is a modular wall mounting system for menu board installations of any size and features pop-in, pop-out interface arms designed to aid installation and allow access to the rear of the screens for servicing and maintenance. As part of the System X range, the BT8331 features a contemporary, lightweight yet incredibly strong design with a high-end aesthetic quality and 8-point micro-adjustment for seamless screen alignment.

SPECIFICATION	
Recommended screen size	32" - 65"
Max load	50kg (per screen)
Depth (with micro-adjustment)	119mm to 133mm
Depth (popped out with micro-adjustment)	298mm to 313mm
VESA® & non-VESA fixings (max vertical dimension)	400mm*
Colour (VESA arms)	Black
Colour (horizontal rail)	Silver

*The VESA specification of the BT8331 refers to the vertical dimension only. All System X interface arms can be positioned as far along the rail as necessary. It is also possible to increase the maximum vertical fixing to 600mm by using BT7564 interface adaptor arms (available separately). Please note that using these adaptors will increase the total depth on the install by 20mm.

FEATURES

- Universal design suitable for all sized screens up to 50kg (per screen)
- Features pop-in, pop-out function to allow access to the rear of screens for servicing and maintenance and to aid installation
- Tool-less micro-adjustments at 8 points for seamless display alignment
- Suitable for landscape or portrait mounting
- High-end aesthetic quality
- Safety screws help prevent unauthorised removal of screens
- Ideal for recess mounting menu boards
- Arms include locking screw to prevent accidental pop-out of screens
- Cable management included for a neat and tidy installation
- Multiple rail lengths available (rails can also be joined to create larger installs)



CREATE YOUR MOUNTING SYSTEM ONLINE

SPECIFY YOUR VIDEO WALL & MENU BOARD REQUIREMENTS ONLINE AND OUR SYSTEM X CONFIGURATION TOOL WILL CREATE A MOUNTING KIT TO SUIT YOUR NEEDS

There are thousands of System X configurations available! Visit our online configuration tool to specify setups, number of screens, number of rows and orientation.

Try now at www.btechavmounts.com/systemx-configurator



Tool-less micro-adjustment at 8 points for seamless display alignment

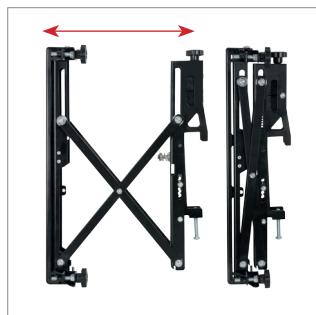

Push to open / push to close system provides quick and easy service access



Multiple rail lengths available (rails can also be joined to create larger installs)



Safety screws help prevent unauthorised removal of screens





BT8331 configurations are made to your exact requirements and, as a result, utilise a varying combination of System X components in order to create the perfect solution. Below are technical drawings for the standard components used in every BT8331 configuration: **BT8390-VESA400MAP** Pop-Out Interface Arms, **BT8390-WFK2** Wall Fixing Kit and **BT8390** Mounting Rails (available in the lengths shown). Please visit our System X online configuration tool at www.btechavmounts.com/systemx-configurator to specify your requirements. All dimensions will be automatically calculated and a complete mounting solution with all required parts will be created for you.

BT8390-VESA400MAP INTERFACE ARMS

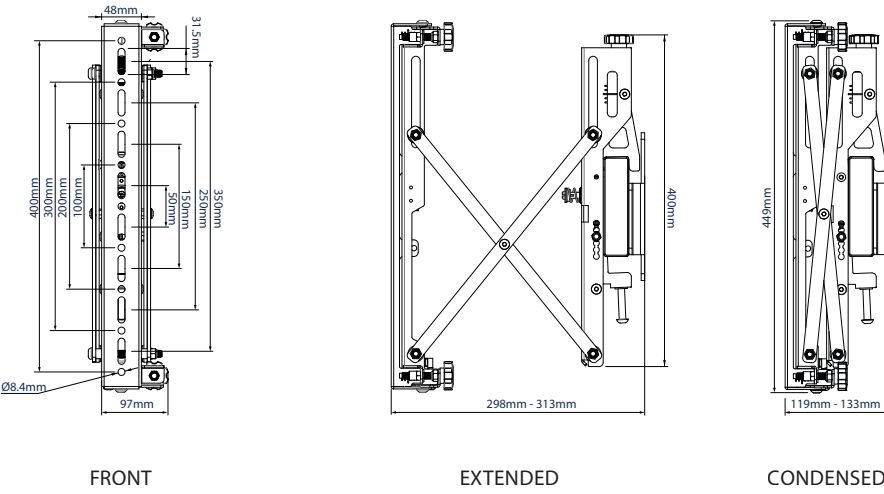

BT8390-WFK2 WALL FIXING KIT

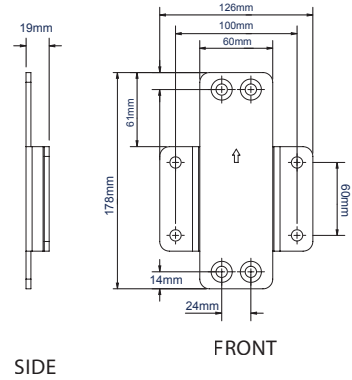

BT8390 MOUNTING RAIL LENGTHS

BT8390-200

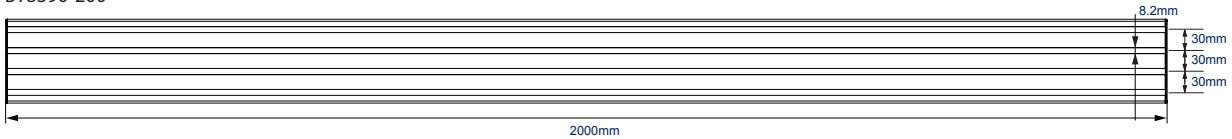

BT8390-175

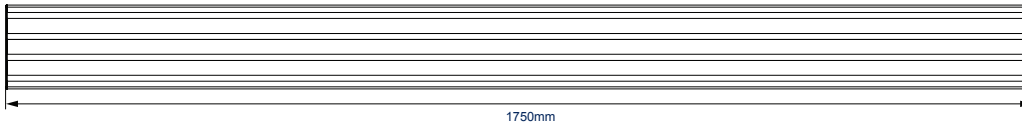

BT8390-150

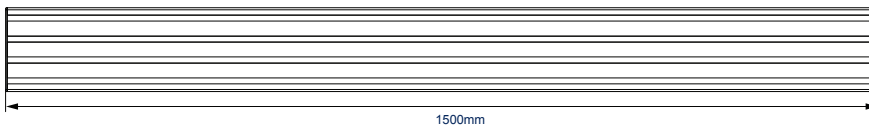

BT8390-070

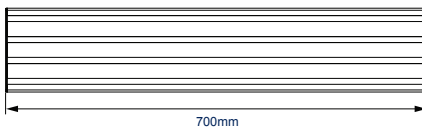

BT8390-050

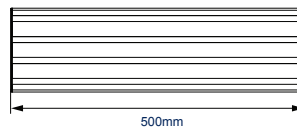

BT8390-030

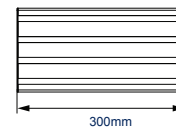

ACCESSORIES AND RELATED PRODUCTS

BT8330



Universal Menu Board Mounting System for wall mounted menu board configurations

BT8332



Universal Ceiling Mounted Menu Board System for menu board configurations

BT8340

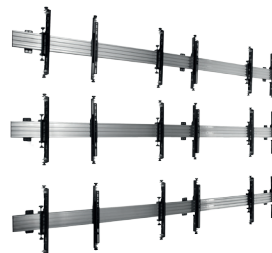

Universal Video Wall Mounting System for video wall configurations

BT8341

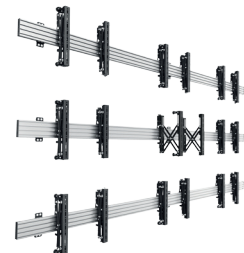

Universal Pop-In, Pop-Out Video Wall System for video wall configurations

© 2016 B-Tech Av Mounts. All rights reserved. The information in this specification is subject to change without notice. B-Tech Av Mounts and the B-Tech logo are registered trademarks of B-Tech International Design & Manufacturing Ltd. All other trademarks are the property of their respective owners. B-Tech Av Mounts is not liable for loss or damage caused by improper installation or use. Any reproduction or transmission of any part of this specification is expressly prohibited unless prior written permission has been granted by B-Tech International Design & Manufacturing Ltd. (B-Tech).
 SS-BT8331-V1-1-151116