



FOR PORTRAIT
 & LANDSCAPE
 MOUNTING

BT8504

LARGE FLAT SCREEN TROLLEY

Designed for large screens mounted in landscape or portrait style, the BT8504 is ideal for all professional applications. A simple 'hook-on' installation makes fitting a screen to the trolley quick and easy. Available in two colour options, the BT8504 also includes non-marking braked castors and optional adjustable levelling feet, to create either a portable or freestanding configuration.

SPECIFICATION

Recommended screen size	up to 70"
Max load	70kg
VESA® fixings	up to 600 x 400
Universal fixings	up to 755 x 410mm
Dimensions (with castors)	W: 1130mm H: 1681mm D: 769mm
Colour (base)	Black
Colour (poles)	Black or Chrome

FEATURES

- Universal design suitable for screens in a landscape or portrait orientation
- Available in two colour options
- Security Allen key and screws provided
- Non-marking 4" locking / braked castors included
- Also supplied with optional screw in levelling feet to create a freestanding configuration
- Collar compatible accessories such as shelves (available separately) can be fitted directly to the poles
- Integrated cable management for a neat and tidy installation
- Simple 'hook-on' screen installation
- All mounting hardware included

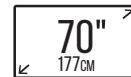

POLES

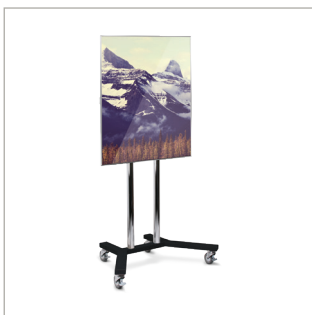

Universal design suitable for screens in portrait or landscape orientation



Collar compatible accessories such as shelves (available separately) can be fitted directly to the poles



Non-marking 4" locking / braked castors included



Also supplied with optional screw in levelling feet to create a freestanding configuration



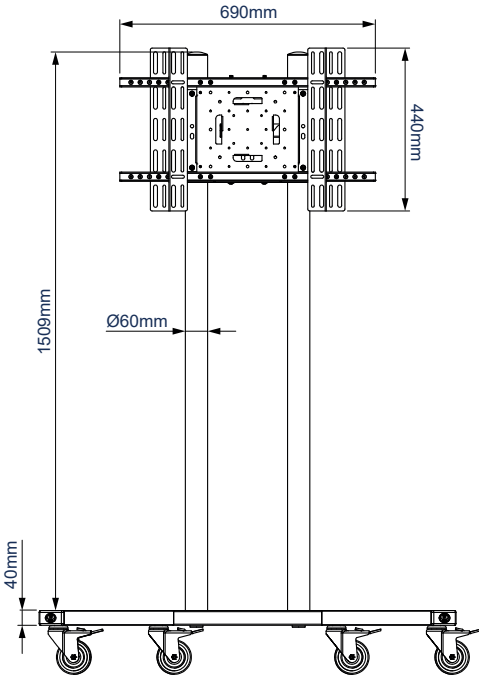

FRONT VIEW WITH CASTORS

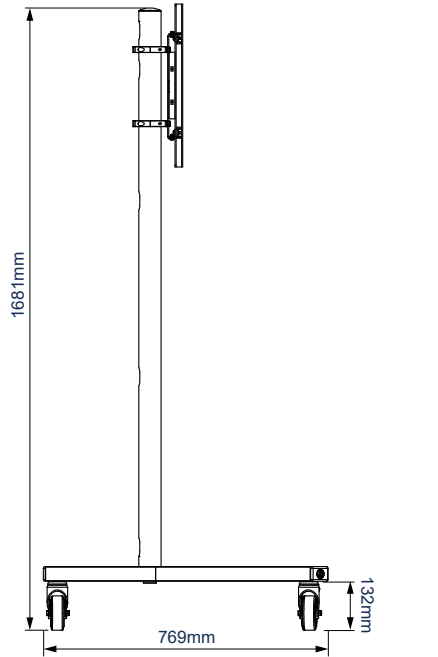

SIDE VIEW WITH CASTORS

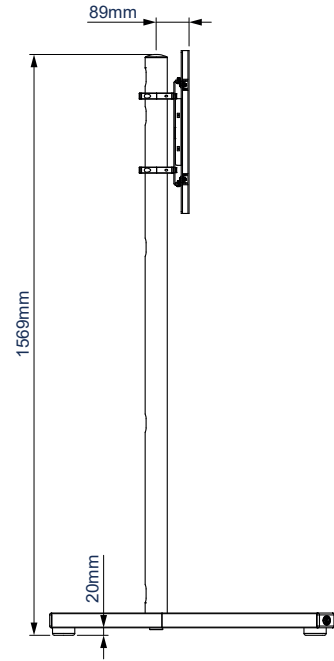

SIDE VIEW WITH LEVELLING FEET

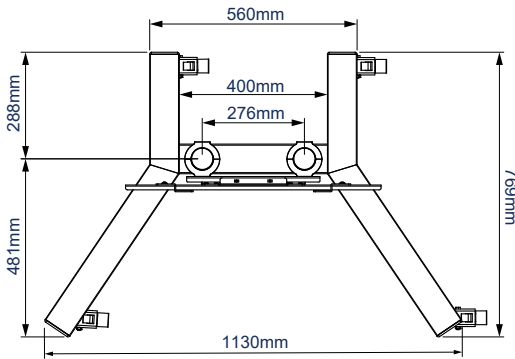

TROLLEY BASE

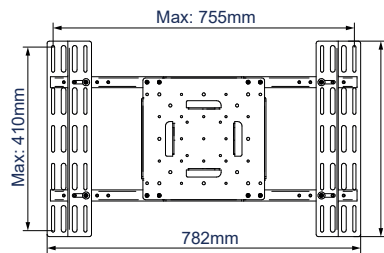

UNIVERSAL INTERFACE PLATE

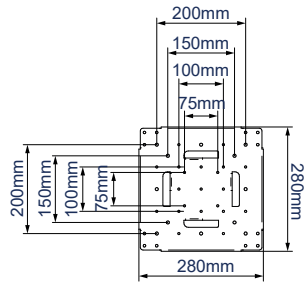

VESA INTERFACE PLATE

PACKING INFORMATION

PLEASE NOTE, THIS IS A **MULTI-BOX ITEM**

COLOUR:	ORDER REF:	EAN CODE:	MASTER CARTON QTY:	INNER CARTON QTY:	MASTER CARTON WEIGHT:	MASTER CARTON CUBE:
Black Base & Black Poles	BT8504/BB	5019318085413	1	0	23.4kg / 9kg	0.075cbm / 0.014cbm
Black Base & Chrome Poles	BT8504/BC	5019318085406	1	0	23.4kg / 9kg	0.075cbm / 0.014cbm

ACCESSORIES AND RELATED PRODUCTS

BT7260



60mm Accessory Collar for fixing mounts and accessories to Ø60mm poles

BT7032



Large AV Accessory Shelf is ideal for adding AV accessories such as a Blu-Ray player or laptop to an installation

BT8508



Trolley for 84" Microsoft® Surface Hub and other interactive displays over 72"

BT8506



Extra-Large Flat Screen Display Trolley for screens up to 120"

© 2015 B-Tech International Design & Manufacturing Limited. All rights reserved. The information in this specification sheet reflects the current technical specifications at the time of printing. B-Tech International Design & Manufacturing Limited is not responsible for any errors or omissions in this document. All dimensions are in millimeters unless otherwise stated. All dimensions are given as maximum dimensions. B-Tech International Design & Manufacturing Limited is not responsible for any damage caused by improper installation or mounting on unsuitable structures. Any reproduction or misrepresentation of any part of this specification is strictly prohibited without the prior written permission of B-Tech International Design & Manufacturing Limited. B-Tech