

---

# **Intelligent Speed Dome User's Manual**

**V 1.0.1**

---

# Table of Contents

<b>1</b>	<b>OVERVIEW.....</b>	<b>1</b>
1.1	General Introduction.....	1
1.2	Features.....	1
<b>2</b>	<b>PREPARATION BEFORE USE .....</b>	<b>4</b>
2.1	Network Speed Dome Setup .....	4
2.1.1	Modify IP Address.....	4
2.1.2	WEB Interface Login.....	6
2.2	Analog Speed Dome Setup.....	7
2.3	HDCVI Speed Dome Setup.....	9
<b>3</b>	<b>MENU DESCRIPTION .....</b>	<b>10</b>
3.1	Open Menu .....	10
3.1.1	Analog Speed Dome and HDCVI Speed Dome.....	10
3.1.2	Network Speed Dome .....	11
3.2	Menu Index.....	12
3.3	Menu Function and Operation Introduction .....	14
3.3.1	System Setting .....	14
3.3.2	Display Setting .....	17
3.3.3	Camera Setting .....	19

---

3.3.4	Function Setting .....	28
3.3.5	Alarm Setting .....	38
3.3.6	Wiper Setting .....	39
3.3.7	IR Light Setting.....	39
3.3.8	White Light Setting.....	40
3.3.9	Laser Setting.....	41
<b>4</b>	<b>SYSTEM CONNECTION .....</b>	<b>42</b>
4.1	System Diagram.....	42
4.2	Alarm Connection .....	42
<b>5</b>	<b>DAILY MAINTENANCE.....</b>	<b>43</b>
5.1	Regular Cleaning.....	43
5.2	Problems and Solutions .....	43
<b>6</b>	<b>APPENDIX I LIGHTNING PROOF AND SURGE PROTECTION.....</b>	<b>44</b>

---

## **Welcome**

Thank you for purchasing our product!

This user's manual is designed to be a reference tool for the operation of your system.

Here you can find information about this speed dome features and functions, as well as a detailed menu tree.

Please keep it well for future reference!

**Before installation and operation, please read the following safeguards and warnings carefully!**

---

# Important Safeguards and Warnings

## 1 . Electrical safety

- All installation and operation here should conform to your local electrical safety codes.
- The power shall conform to the requirement in the SELV (Safety Extra Low Voltage) and the rated voltage of Limited Power Source is provided according to IEC60950-1.
- We assume no liability or responsibility for all the fires or electrical shock caused by improper handling or installation.
- We are not liable for any problems caused by unauthorized modification or attempted repair.

## 2 . Transportation Security

- No heavy stress, violent vibration or water splash are allowed during transportation, storage and installation.
- Please use the original packing material (or the material of the same quality) when you ship it back to the manufacturer.

## 3 . Installation

- Do not apply power to the product before completing installation.
- Please install the proper power cut-off device during the installation connection.
- Do not put object on the product.

## 4 . Environment

- This series product should be installed in a cool, dry place away from direct sunlight, inflammable, explosive substances and etc.
- Please keep it away from the electromagnetic radiation object and environment.
- Please keep the sound ventilation.
- Do not allow the water and other liquid falling into the device.
- Please make sure the CCD (CMOS) component is out of the radiation of the laser beam device. Otherwise it may result in CCD (CMOS) optical component damage.
- Thunder-proof device is recommended to be adopted to better prevent thunder.
- The grounding holes of the product are recommended to be grounded to further enhance the reliability of the camera.

## 5. Daily Maintenance

- Current series product has no power button. Please unplug all corresponding power cables before your begin installation or daily maintenance work.
- Please keep the dustproof cap back to protect the CCD or CMOS part if the device does not work for a long time.
- Do not touch CCD (CMOS) component. You can use the blower to clean the dust on the surface of the device. You can use the dry cloth with some alcohol or mild detergent to clear if necessary.
- Do not use the volatility solvent such as the benzene or thinner, or detergent with strong abrasibility. It may result in lens damage or it may adversely affect the device performance.

- 
- If there is too much dust, please use the water to dilute the mild detergent first and then use it to clean the device. Finally use the dry cloth to clean the device.

- **6. About Accessories**

Always use all the accessories recommended by manufacturer.

Before installation, please open the package and check that all the components are included in the package:

Contact your local retailer ASAP if something is missing in your package.

---

# 1 Overview

## 1.1 General Introduction

Intelligent speed dome is a type of product with high integration and intelligentization. It adopts new structure design with convenient installation, which causes no influence over the monitoring scene after the device is installed. Meanwhile, the product is embodied with several features such as clear image, digitalization, intelligentization and convenient installation etc.

## 1.2 Features

### HD Video

It supports megapixel resolution.

### Transmission without Any Loss

It supports more than 500M transmission distance via general 75-3 coaxial cable.

#### Note:

It is only supported by some intelligent speed domes.

### Coaxial Control

It supports coaxial transmission for control signal.

#### Note:

It is only supported by HDCVI intelligent speed dome.

### OSD Menu

Intelligent speed domes support OSD menu display in both Chinese and English which also can be switched. It can display various information of the speed dome via menu, set each function and set various parameters of the camera.

### Zoom Speed Limit

Intelligent speed domes adopt the auto match technology between focal length and rotation speed. The pan and tilt speed of the speed dome is changed with that of the zoom rate, the camera moves slower when the zoom rate increases. The camera moves faster when the zoom rate decreases.

### Screen Display

Screen operation prompt, it can display call preset, preset number, title, system temperature and azimuth during tour via menu settings.

### Preset

Preset function is to make the speed dome save the address parameters into the memorizer (such as PTZ pan/tilt, focal length and etc.), and it can quickly call these parameters to adjust the PTZ and camera to the location when necessary, the operator can store and call preset via control keyboard conveniently.

### Auto Scan

It is the function that the speed dome can horizontally scan back and forth to display image with a certain speed in a certain range. The speed dome can scan back and forth with a certain speed in a set range after left and right limit and scan speed are set. The function can be realized via OSD as well.

### Auto Tour

It is the built-in function that it can arrange some presets into the auto tour list according to the needed sequence via programming in advance, and then the users can make the speed dome move back and forth at a regular interval according to the preset sequence which is set in advance via control keyboard conveniently.

### Pattern

---

Memorize dome operation such as pan, tilt, and zoom to repeat. You can call it to repeat the previous operation.

### **Privacy Mask**

The users can set the screen area which can be masked by the operator, the masked area will move together with the speed dome horizontally and vertically, it will change as the image size changes, the invisible image area is always masked.

### **Relay Activation**

It can connect 7 NO or NC on-off input and 2-channel NO alarm output via connector assembly. The relay activation can set the speed dome to implement preset activation actions when receiving alarm.

### **Auto Flip**

It allows the users to track object manually, when the object directly passes below the camera, it can directly operate the joystick on the keyboard to make the speed dome auto flip 180° horizontally to guarantee tracking continuity.

### **Power on Self Test**

The speed dome can implement self test function after it is powered on. Mainly it includes motor self test and camera self test horizontally and vertically, it is mainly about the zoom function self test and meanwhile it will display the system information of the speed dome.

### **Day/Night Switch**

There are several day/night switch modes to be set, which are auto, manual, timing and etc.

#### **Note:**

The function above depends on the device module.

### **Auto Focus**

It supports the function of auto focus adjustment for the camera.

### **Backlight Compensation**

The object becomes dark when there is strong light in the background. The BLC function is to implement brightness compensation automatically upon the darker target in the background with strong light; it is to adjust the scene with high brightness, which is to avoid overexposure of the entire image due to over brightness of the background, and the target is hard to be recognized due to darkness. By this way, the camera is able to acquire clear image.

### **PTZ/Zoom Concurrent Operation**

The speed dome can implement zoom operation while it is implementing pan and tilt, meanwhile it can pause any one of the operation (pan, tilt or zoom). The auto focus and auto iris adjustment of the speed dome can guarantee stable and clear image.

### **3D Intelligent Positioning**

It supports 3D intelligent positioning function; the speed dome can track to the selected area automatically.

### **Idle Action**

The speed dome will implement the idle action which is set in advance if it doesn't receive any external effective orders for a while.

### **Power up**

The speed dome will implement power up actions after reboot and self-test, the power up actions include six setting items which are auto, preset, scan, tour, pattern and none.

### **Image Dejitter/Flip**



---

It can enable the image dejitter and image flip via menu operation. The image dejitter function can make the image more stable when the device is located in an environment with vibration. While the image flip function can make it more convenient to check image.

**Note:**

The function depends on the device module.

---

## 2 Preparation before Use

It needs to implement relevant settings before controlling the intelligent speed dome:

- Network speed dome: All the speed domes have the uniform IP address when they are delivered out of factory (default IP: 192. 168.1.108), it needs to reasonably plan the available IP network segment according to the actual network environment in order to make the speed dome get access to network smoothly.
- Analog speed dome: First it has to set the address No, baud rate and parity for the speed dome, then the device will respond to the control commands after the settings.
- HDCVI speed dome: First it has to set control mode and protocol at the back-end coding device, and then it can control the speed dome.

### 2.1 Network Speed Dome Setup

**Note:**

Only some network speed domes support OSD menu, please refer to the actual device for more details. The figures below are for reference only.

#### 2.1.1 Modify IP Address

The intelligent speed dome can acquire and modify IP address via quick config tool, please refer to 《Config Tool\_ User Manual》 for more details.

**Note:**

Currently the quick config tool can only support to search the camera which is in the same network segment as that of the computer IP address.

**Step 1**

Double click the “ConfigTools.exe” and open the quick configuration tool.

**Step 2**

Double click the device to be configured; the system will pop out the “Login” dialog box. Enter the IP address, user name, password and port number of the camera, and click “Confirm”.

**Note:**

The default user name and password are admin and admin respectively, the default port is 37777. See Figure 2-1 for more details.

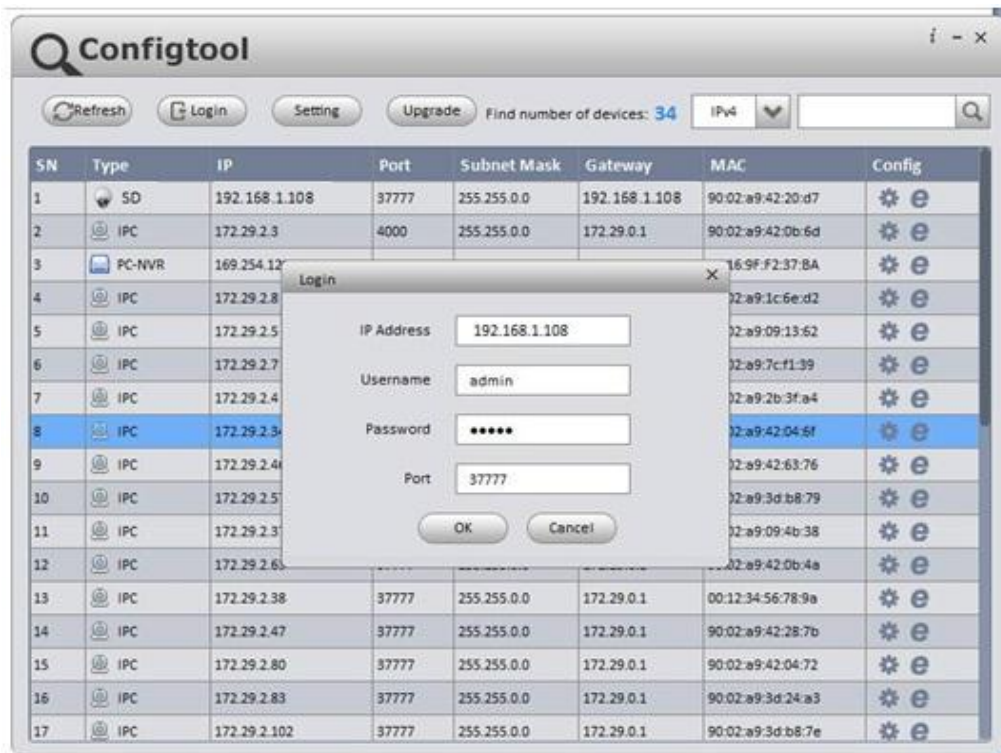

Figure 2-1

**Step 3**

Modify the camera IP address on the “Net” interface, click “Save” to finish modification.

See Figure 2-2 for more details.



Figure 2-2

---

## 2.1.2 WEB Interface Login

### Note:

Different devices may have different WEB interfaces, the figures below are just for reference, please refer to the document <<WEB Operation Manual>> in the disk and the actual interface for more details

### Step 1

Open IE and input the modified camera IP address in the address bar.

### Step 2

The login interface is shown below; please input your user name and password (Default user name is admin and password is admin respectively), click “login”.

See Figure 2-3 for more details.



Figure 2-3

### Step 3

Install controls according to the system prompt; see Figure 2-4 for the WEB main interface. Please modify the administrator password as soon as possible after you successfully logged in.

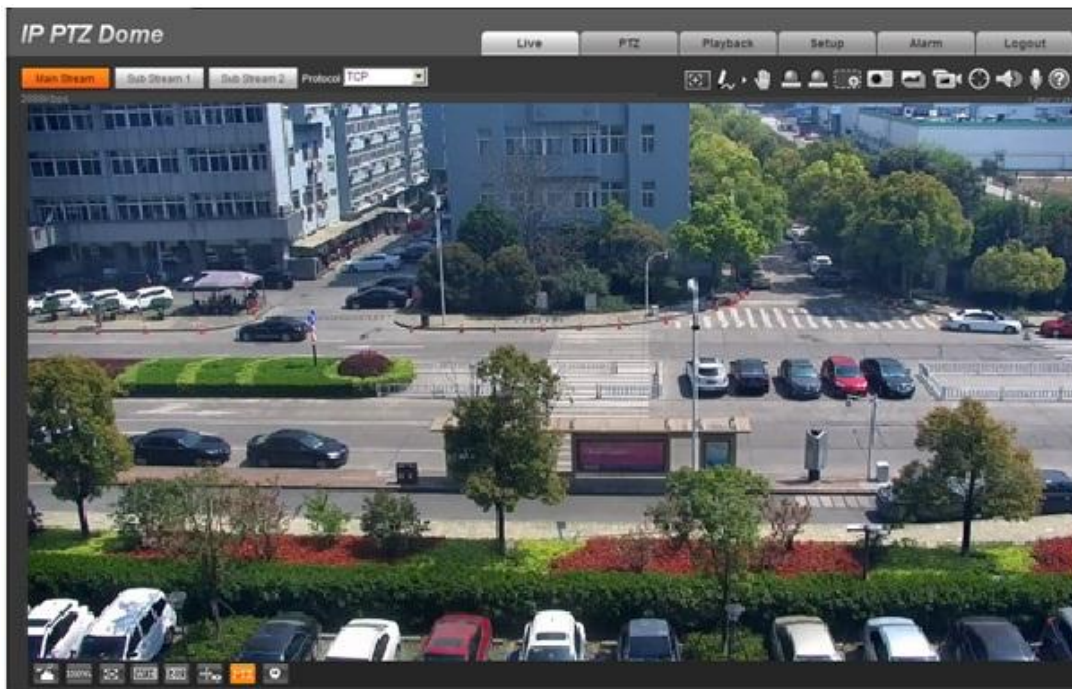

Figure 2-4

Note:

WEB interface may be different according to different products, please refer to the actual product for more details.

## 2.2 Analog Speed Dome Setup

Users must set the address number, Baud rate and parity which are used by the speed dome before controlling it. Only after all these settings, can the speed dome respond to its control commands.

Note:

The dial location and structure may be different according to the different intelligent speed domes, please refer to the corresponding installation manual for more details. The following figure is for reference only.

The dial switch of the speed dome is shown in Figure 2-5; it has to reboot to make the new settings valid after relevant info (baud rate, address and etc.) being reset.

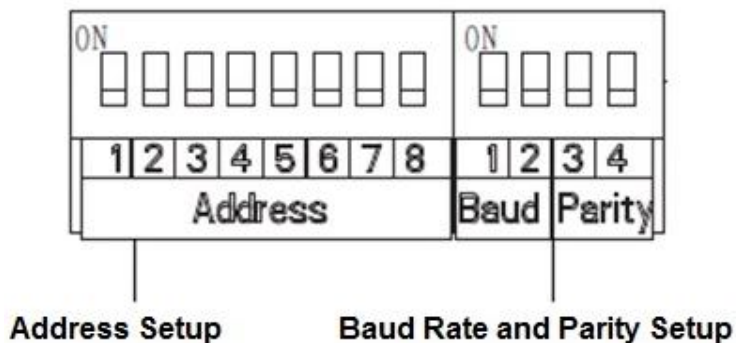

Figure 2-5

When the switch is moved to ON as 1, then 1 is the lowest bit and 8 is the highest bit in the address setup dial; in the Baud rate and parity setup dial, 1 is the lowest bit and 4 is the highest bit.

**Note:**

Intelligent speed dome can self-adapt PELCO-D; PELCO-P, and industrial standard protocol, control protocol doesn't need to be realized via dial setup.

**Baud Rate and Parity Setup**

From dial number 1~4, 1 and 2 are baud rate bit, 3 and 4 are parity bit.

1	2	Baud rate
OFF	OFF	9600bps
ON	OFF	4800bps
OFF	ON	2400bps
ON	ON	1200bps

Sheet 2-1

3	4	Parity
OFF	OFF	NONE
ON	OFF	EVEN
OFF	ON	ODD
ON	ON	NONE

Sheet 2-2

**Speed Dome Address Setup**

The speed dome uses dial switch to set address, the encode mode adopts binary system. 1 to 8 is valid bit. The highest address bit is 255. You can refer to the following sheet 2-3 for more information.

Address	1	2	3	4	5	6	7	8
1	OFF	OFF	OFF	OFF	OFF	OFF	OFF	OFF
1	ON	OFF	OFF	OFF	OFF	OFF	OFF	OFF
2	OFF	ON	OFF	OFF	OFF	OFF	OFF	OFF
3	ON	ON	OFF	OFF	OFF	OFF	OFF	OFF
4	OFF	OFF	ON	OFF	OFF	OFF	OFF	OFF
5	ON	OFF	ON	OFF	OFF	OFF	OFF	OFF
6	OFF	ON	ON	OFF	OFF	OFF	OFF	OFF
7	ON	ON	ON	OFF	OFF	OFF	OFF	OFF

Address	1	2	3	4	5	6	7	8
8	OFF	OFF	OFF	ON	OFF	OFF	OFF	OFF
.....	.....							
254	OFF	ON	ON	ON	ON	ON	ON	ON
255	ON	ON	ON	ON	ON	ON	ON	ON

## 2.3 HDCVI Speed Dome Setup

**Note:**

It needs to match corresponding HCVR when controlling speed dome via coax.

It needs to set control mode as “HDCVI” and the protocol as “HD-CVI” on the DVR PTZ interface before controlling speed dome via coax, it doesn’t need to set address and baud rate, please refer to Figure 2-6 for more details.



Figure 2-6

Please refer to 《Digital Video Recorder (HCVR series) User Manual》 for more details.

Meanwhile, you can set video output mode (CVI, TVI, AHD or SD) via UTC controller as well, please refer to the user manual of UTC controller for exact setting mode.

After the setting is completed, connect the speed dome to the HCVR with video cable and then you can control the speed dome.

### 3 Menu Description

Install the speed dome and power it on, then the speed dome will implement self-test. The self-test is normal and the screen info is shown in Figure 3-1, the prompt message will disappear after the speed dome received the first valid control command or the display time is over 20s.

ADDRESS:	1-S
BAUD RATE:	9600
PARITY:	NONE
SOFTWARE VERSION:	2.03.87.T

Figure 3-1

Menu item	Note
Address	It is to display the address info of the speed dome, such as 1-S: 1 means address number, -S means software address mode.
Baud rate	It is to display the communication baud rate currently used by speed dome.
Parity	It is to display the communication parity bit mode which is used currently.
Software version	It is to display the software version number of the speed dome.

**Note:**

Please set the control information of the speed dome over control keyboard or matrix host the same as that of the speed dome when you are using control keyboard or matrix host as the control device of the speed dome (include address, baud rate, parity), meanwhile please make sure the system is correctly connected.

### 3.1 Open Menu

#### 3.1.1 Analog Speed Dome and HDCVI Speed Dome

You can open OSD menu by the following method for analog speed dome and HDCVI speed dome:

**Step 1**

Click the right button on the back-end DVR device, select “PTZ Control”, and it will pop out the interface of “PTZ Control”, which is shown in Figure 3-2.



Figure 3-2

**Step 2**



Click  to unfold the menu, click  to enter the menu, which is shown in Figure 3-3.





Figure 3-3

**Step 3**

Click the up and down direction buttons on the “Menu Operation” to select menu item, click left and right direction buttons to select parameter value, and click “Enter” to confirm, see Figure 3-4.

Click “OK” button to enter sub menu if there is one.



Figure 3-4

**3.1.2 Network Speed Dome**

There are two ways to open OSD menu for the network speed dome: via back-end storage device and WEB interface. The previous operation mode is the same as that of the analog and HDCVI speed dome. Here we are going to mainly introduce the way to open OSD menu via WEB interface.

**Step 1**

Log in the WEB interface of the speed dome, select the “Menu” page, which is shown in Figure 3-5.



Figure 3-5

---

Step 2

Click “Open” to enter the menu.

Step 3

Click the up and down direction buttons to select menu item on the “Menu” page, click left and right direction buttons to select parameter value, and click “OK” button to make it confirm.

Click “OK” button to enter sub menu if there is one.

## 3.2 Menu Index

### Note:

- ERR on the screen menu means there is error about the parameter, please restore factory default.
- The intelligent speed dome parameters may be different between different models, please refer to the actual product for more details. The menu item listed below is the most complete one.

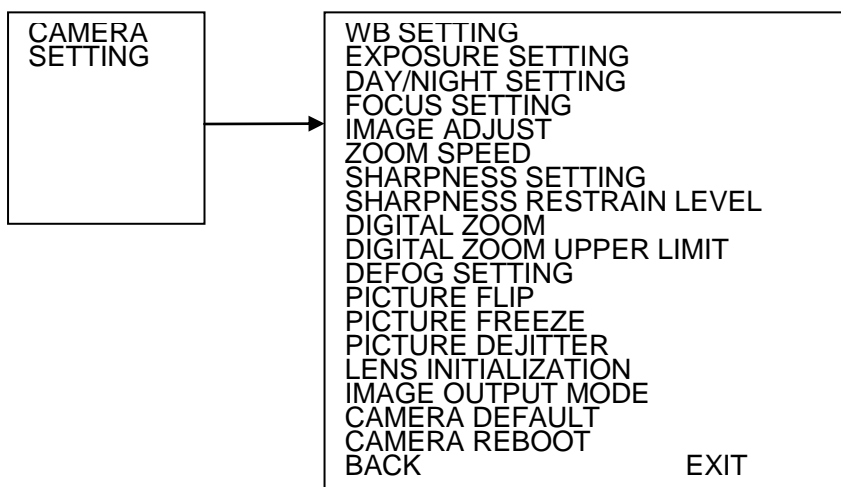
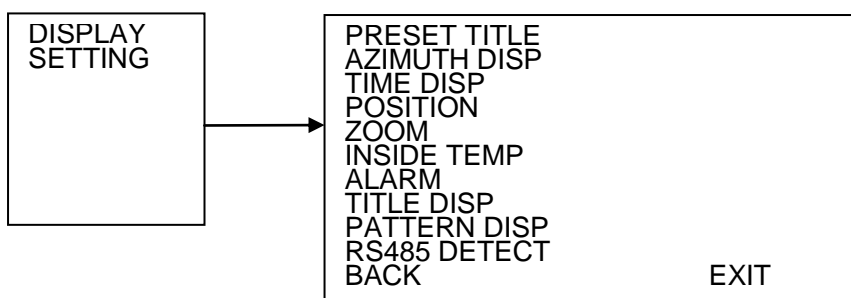
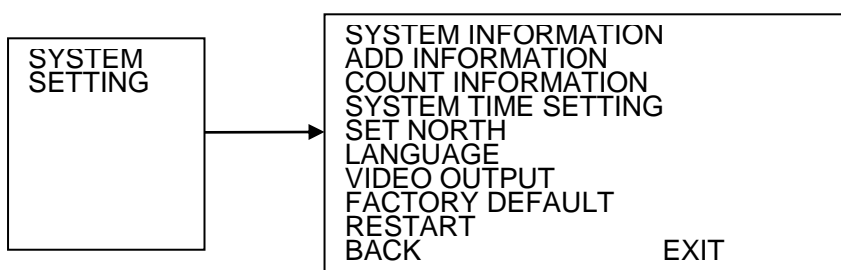

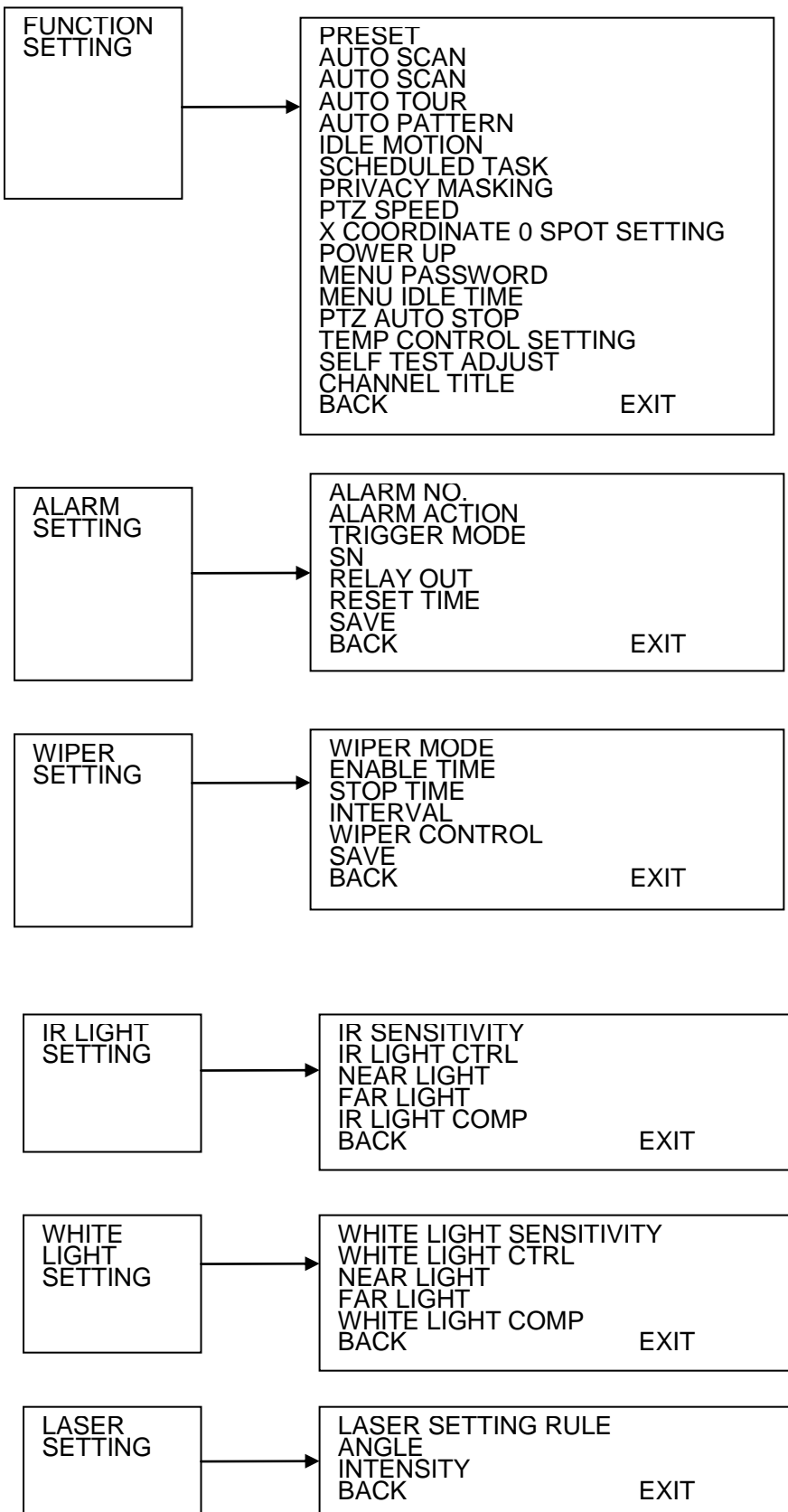

Figure 3-6

### 3.3 Menu Function and Operation Introduction

SYSTEM SETTING DISPLAY SETTING CAMERA SETTING FUNCTION SETTING ALARM SETTING WIPER SETTING IR LIGHT SETTING LASER SETTING EXIT
--

Figure 3-7

Menu Item	Note
System Setting	It is to display the system info, address info, statistics info; it can set system time, north, language, video output, factory default, system reboot.
Display Information	It is to control preset title, azimuth, time, direction, zoom info, inside temp, alarm info, title info, pattern, RS495 detect info to display on the screen.
Camera Setting	It is to set the speed dome functions such as WB, exposure, day/night, focus, image adjust, zoom speed, sharpness, sharpness restrain level, digital zoom, digital zoom upper limit, defog, image flip, image freeze, image dejitter, lens initialization, camera default, camera reboot etc.
Function Setting	It is to set the preset, pan, auto scan, auto tour, auto pattern, idle motion, timing task, privacy mask, PTZ speed, X coordinate 0 spot, power up, menu password, menu idle time, PTZ auto stop, temp control, self test adjust etc.
Alarm Setting	It is to set the speed dome alarm number, alarm action, trigger mode, serial number, alarm output, reset time etc.
Wiper Setting	It is to set wiper mode, enable time, stop time, interval, wiper control etc.
IR Light Setting	It is to set IR light sensitivity, control rule, near light, far light, IR light compensation etc.
Laser Setting	It is to set laser control rule, angle, intensity etc.
Exit	Exit the menu.

#### 3.3.1 System Setting

Move the cursor to “System Setting”, click “OK” to enter the second menu, which is shown in Figure 3-8.

```
SYSTEM SETTING
ADD SETTING
COUNT INFO
SYSTEM TIME SETTING
SET NORTH
LANGUAGE
VIDEO OUTPUT
FACTORY DEFAULT
SYSTEM RESTART
BACK                               EXIT
```

Figure 3-8

**3.3.1.1 Check System Info**

Move the cursor to “System Info” and click “OK” to enter the third menu; here you can check the speed dome address, baud rate, parity, software version etc.

```
ADDRESS           : 1-S
BAUD RATE         : 9600
PARITY            : NONE
SOFTWARE VERSION: 2.02.14.RHIRFZ
BACK              EXIT
```

Figure 3-9

**3.3.1.2 Set Speed Dome Address**

Step 1

Move the cursor to “Address Info” and click “OK” to enter the third menu, which is shown in Figure 3-10.

```
ADDR TYPE        : HARD ADDRESS
ADDR-HARD        : 001
ADDR-SOFT        : 001
BACK              EXIT
```

Figure 3-10

Step 2

Click UDLR buttons to set the address info of the speed dome.

- Select address type according to the specific application scene; you can select hard address when it is convenient for application, select software address when it is inconvenient.
- Please use hardware address when it is set as hard address, which means the address set by dial switch can't be modified via software.
- Please use software address when it is set as soft address, you can directly modify in the menu of the speed dome; the address range is from 0 to 255.

**3.3.1.3 Check Count Info**

Move the cursor to “Statistics Info” and click “OK” to enter the third menu; you can check the operation situation of the speed dome in this menu, which is shown in Figure 3-11.

RUNNING TIME	: 87
NEAR LIGHT TIME	: 2
FAR LIGHT TIME	: 2
HIGH TEMP TIME	: 87
LOW TEMP TIME	: 0
LEVEL MOVE NUM	: 1
VERT MOVE NUM	: 0
DAY NIGHT NUM	: 67
BACK	EXIT

Figure 3-11

### 3.3.1.4 Set System Time

#### Step 1

Move the cursor to “System Time Setting” and click “OK” to enter the third menu, which is shown in Figure 3-12.

YEAR	: 2015
MONTH	: 11
DAY	: 12
WEEK	: THU
HOUR	: 16
MIN	: 55
SAVE	
TIME SYNC	: ON
BACK	EXIT

Figure 3-12

#### Step 2

Click UDLR buttons to set the system time of the speed dome.

#### Step 3 (Optional)

Enable “Time Sync”, it can synchronize the time of HCVR with speed dome when HCVR device supports the function of time sync.

#### Note

The time will be restored to default after rebooting the device whose function of time sync is not enabled.

#### Step 4

Click “Save” to complete setting.

### 3.3.1.5 Set North

#### Step 1

It is to adjust monitoring direction to the north via control direction buttons on PTZ.

#### Step 2

Move the cursor to “Set North” and click “OK”, then the screen display “OK”, which means setting is valid.

### 3.3.1.6 Set Menu Language

#### Step 1

Move the cursor to “language”.

#### Step 2

Click left and right buttons to select language.

#### Step 3

Click “OK” to make setting valid.

---

### 3.3.1.7 Set Video Output Mode

**Note:**

- The function is only supported by HDCVI intelligent speed dome.
- Please confirm if HCVR supports corresponding output mode before switching video output mode, otherwise it will cause image and coaxial control abnormality.

Step 1

Move the cursor to “Video Output”.

Step 2

Click left and right buttons to select output mode, you can select CVI, TVI, AHD or SD.

Step 3

Click “OK”.

### 3.3.1.8 Factory Default Setting

Move the cursor to the “Factory Default Setting” and click “OK” to restore the factory default setting of the speed dome.

### 3.3.1.9 System Reboot

Move the cursor to the “System Reboot” and click “OK” to reboot the system.

## 3.3.2 Display Setting

Move the cursor to the “Display Setting” and click “OK” to enter the second menu, which is shown in Figure 3-13.

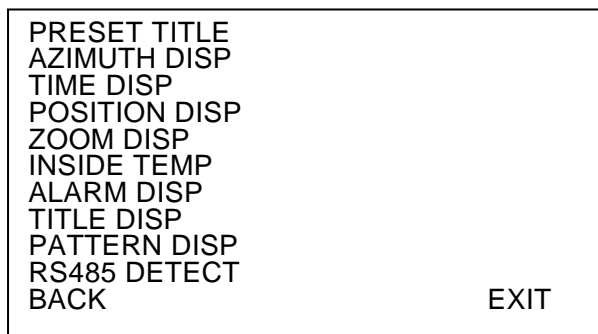

Figure 3-13

### 3.3.2.1 Set Preset Title Display

The function is used to set if the preset title is displayed on the control screen.

**Note:**

First the users need to set corresponding preset number and preset title in “Function Setup > Preset”, please refer to “3.3.4.2 Preset Setup” for more details.

Step 1

Move the cursor to “Preset Title”.

Step 2

Click left and right buttons to select “On/Off”.

---

### 3.3.2.2 Set Azimuth Display

The function is used to set if the current coordinate value of the speed dome is displayed on the monitoring screen.

Step 1

Move the cursor to "Azimuth Display".

Step 2

Click left and right buttons to select "On/Off".

### 3.3.2.3 Set Time Display

The function is used to set if the current time of the speed dome is displayed on the monitoring screen.

Step 1

Move the cursor to "Time Display".

Step 2

Click left and right buttons to select "On/Off".

### 3.3.2.4 Set Position Display

The function is used to set if it is to display the deviation angle of reference position of the current lens on the monitoring screen.

Step 1

Move the cursor to "Position Display".

Step 2

Click left and right buttons to select 'On/Off'.

### 3.3.2.5 Set Zoom Display

The function is used to set if the current optical zoom rate of the speed dome is displayed on the monitoring screen.

Step 1

Move the cursor to "Zoom Display".

Step 2

Click left and right buttons to select "On/Off".

### 3.3.2.6 Set Inside Temperature

The function is used to set if the inside temperature of the speed dome is displayed on the monitoring screen.

Step 1

Move the cursor to "Inside Temp".

Step 2

Click left and right buttons to select "°C/F/Off".

### 3.3.2.7 Set Alarm Display

#### Note

HDCVI speed dome will display alarm menu when HCVR fails to support the function of coaxial alarm.

The function is used to set if the alarm situation of speed dome is displayed on the monitoring screen, it will display the channels which generate alarm after it is enabled, if alarm input 1 product alarm, then it



---

will display “Alarm:1”.

Step 1

Move the cursor to “Alarm Display”.

Step 2

Click the left and right buttons to select “On/Off”.

### 3.3.2.8 Set Title Display

The function is used to set if it is to display the location of speed dome on the monitoring screen; the exact title description can be set via control terminal or channel title of function setting of the speed dome.

Step 1

Move the cursor to “Alarm Display”.

Step 2

Click left and right buttons to select “On/Off”.

### 3.3.2.9 Set Pattern Display

The function is used to set if it is to display the percentage of the current location out of the total pattern path on the monitoring screen.

Step 1

Move the cursor to “Pattern Display”.

Step 2

Click left and right buttons to select “Om/Off”.

### 3.3.2.10 Set RS485 Detection Display

When it is under the circumstance that RS485 connection is wrong, it will display corresponding correct information when users controlling the speed dome (such as correct address, baud rate etc.), the function can be used to set if it is to display the information on the monitoring screen.

Step 1

Move the cursor to ‘RS485 Detection’.

Step 2

Click left and right buttons to select “On/Off”.

## 3.3.3 Camera Setting

Move the cursor to “Camera Setting” and click “OK” to enter the second menu, which is shown in Figure 3-14.

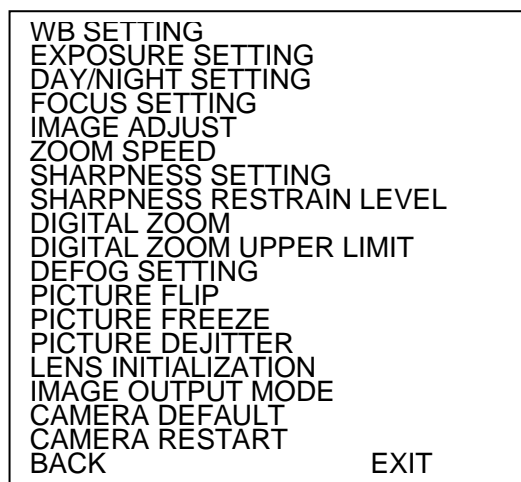

WB SETTING  
EXPOSURE SETTING  
DAY/NIGHT SETTING  
FOCUS SETTING  
IMAGE ADJUST  
ZOOM SPEED  
SHARPNESS SETTING  
SHARPNESS RESTRAIN LEVEL  
DIGITAL ZOOM  
DIGITAL ZOOM UPPER LIMIT  
DEFOG SETTING  
PICTURE FLIP  
PICTURE FREEZE  
PICTURE DEJITTER  
LENS INITIALIZATION  
IMAGE OUTPUT MODE  
CAMERA DEFAULT  
CAMERA RESTART  
BACK EXIT

Figure 3-14

### 3.3.3.1 WB Setting

White balance means the restoration of white object, which can calibrate the color temperature in both indoor and outdoor environment.

The steps of setting white balance are as follows:

Step 1

Move the cursor to “WB Setting” and click “OK” to enter the third menu, which is shown in Figure 3-15.



Figure 3-15

Step 2

Select WB mode.

- Select “manual”
  1. Click left and right buttons to select “Manual”.
  2. Move the cursor to “R Gain”, click left and right buttons to set R gain value.
  3. Move the cursor to “B Gain”, click left and right buttons to set B gain value.
- Select other modes.

Click left and right buttons to select WB mode.

You can select auto, ATW, outdoor, indoor, outdoor auto, sodium lamp auto, sodium lamp and natural, please refer to sheet 3-1 for more details about the parameters.

Menu Item	Note
Auto/ATW	Both are auto white balance adjustment, the color temperature of ATW mode is much wider than that of the Auto mode, but the accuracy and recovery ability is weaker than auto mode. It is auto mode by default.
Outdoor/Outdoor auto	Both can be applied in outdoor environment. The color temperature is fixed in outdoor mode, outdoor auto is a color temperature range, when the color temperature fluctuates in the fixed range, and it is less likely to generate color cast by selecting outdoor auto mode.
Sodium lamp/sodium lamp auto	Both can be applied to sodium lamp environment. Sodium lamp is the fixed color temperature, sodium auto is a color temperature range, when the color temperature fluctuates within a fixed range, and it is less likely to generate color cast by selecting sodium lamp auto mode.

Sheet 3-1

### 3.3.3.2 Exposure Setting

The function is used to set the exposure mode of the speed dome.

The steps of setting exposure are shown as follows:

Step 1

Move the cursor to “Exposure Setting” and click “OK” to enter the third menu, which is shown in Figure 3-16.

RXPOSURE MODE	: AUTO
GAIN SETTING	: 2
SHUTTER SETTING	: 1/50
IRIS SETTING	: 11
EXPOSURE COMP	: 8
SLOW EXPOSURE	: 1
BLC	: OFF
SLOW SHUTTER	: ON
AUTO SS LOWER LIMIT	: 1/25
HIGH GAIN	: ON
AUTO GAIN UPPER LIMIT	: 3
NOISE RESTRAIN	: 2
CAMERA 3D NOISE RESTRAIN	: OFF
GENERAL 3D NOISE RESTRAIN	
EXPOSURE SUPPRESS	: OFF
BRIGHTNESS SUPPRESS	: 50
AUTO EXPOSURE RECOVERY	: 15 MINS
WDR SETTING	
BACK	EXIT

Figure 3-16

Step 2

Click the left and right buttons to select exposure mode.

You can select auto, manual, iris priority, shutter priority, refer to sheet 3-2 for more details about each parameter.

Menu Item	Note
Auto	Gain setting, shutter setting, iris setting are auto adjustment.
Manual	Gain setting, shutter setting, iris setting need to be adjusted manually.
Iris priority	Iris setting adjustable, gain setting and shutter setting are auto adjustment.
Shutter priority	Shutter setting adjustable, gain setting and iris setting are adjusted automatically.

Sheet 3-2

Step 3

Set the following three parameter items according to the exposure mode selected in step 2.

- Gain setting

Move the cursor to “Gain Setting” and click left and right buttons to adjust gain value.

The bigger the value is, the brighter the image becomes.

- Shutter Setting

Move the cursor to “Shutter Setting” and click left and right buttons to adjust shutter value.

The bigger the value is, the darker the image becomes.

- Iris Setting

Move the cursor to “Iris Setting” and click left and right buttons to adjust iris value.

The bigger the value is, the brighter the image becomes.

Step 4

Set the following parameters according to the actual needs.

Menu Item	Note
Exposure compensation	It is to set the exposure compensation of the camera, the bigger the value is, the brighter the image becomes.

Menu Item	Note
Slow exposure	It is to acquire image via extending auto exposure time in strong light condition, it can realize HLS function to some extent. The bigger the value is, the longer the extended exposure time.
BLC	It is to adjust the camera brightness, the camera lens realize auto brightness compensation upon the darker target in the strong light, and adjust the background with high brightness.
Slow shutter	In low light environment, it is to acquire the image via extending auto exposure time, which can effectively reduce the image noise, but it may generate smear for the moving object.
Auto slow shutter lower limit	It is to set the lower limit of auto slow shutter.
High gain	It is to set if it is to enable high gain.
Auto gain upper limit	It is to set auto gain upper limit.
Noise restrain	It may generate noise for the camera in the low light environment, it can use digital filtering to reduce the noise in the image and make the image clear.
Camera 3D noise restrain	It is to implement noise reduction between frames according to the previous several frames and the current frame image. The noise reduction effect is better without affecting image resolution but it may generate smear.
General 3D noise restrain	It is to realize noise restrain effect via the video filtering of time and space domain.
Exposure suppress	It is to suppress the sudden strong light appearing in the image, which is to avoid affecting the image quality.
Brightness suppress	It is to suppress the image brightness.
Auto exposure recovery	It is to set the time of auto exposure recovery.
WDR setting	After WDR function is enabled, the speed dome can auto adjust the image brightness when the comparison of image brightness and darkness is very strong.

Sheet 3-3

### 3.3.3.2.1 Set General 3D Noise Restrain

#### Step 1

Move the cursor to “General 3D Noise Restrain” and click “OK” to enter the fourth menu, which is shown in Figure 3-7.

CONTROL MODE	: AUTO
NR MODE	: DEFAULT
TIME DOMAIN	: OFF
SPACE DOMAIN	: OFF
BACK	: EXIT

Figure 3-17

#### Step 2

Select control mode.

You can select Off, Auto and Manual.

- Select “OFF”

Click left and right button to select “OFF”.

- Select “AUTO”

1. Click left and right button to select “AUTO”.

2. Move the cursor to the “NR MODE” and click left and right button to select “Low/High/Default”.
  - Select “Manual”.
    1. Click left and right button to select “MANUAL”.
    2. Move the cursor to the “TIME DOMAIN” and click left and right button to set time domain. Time domain means collecting multi-frame image data and implement noise reduction upon the image.
    3. Move the cursor to then “SPACE DOMAIN”, click left and right button to set space domain. Space domain means implementing noise reduction upon the image within every single frame data.

### 3.3.3.2.2 Set WDR

#### Step 1

Move the cursor to the “WDR SETTING” and click “OK” to enter the fourth menu, which is shown in Figure 3-18.



Figure 3-18

#### Step 2

Click the left and right button to select the WDR mode as “ON”.

#### Step 3

Move the cursor to the “SENSITIVITY” and click left and right button to set the sensitivity value.

#### Step 4

Move the cursor to “ADJUST LEVEL” and click left and right button to set the intensity level of WDR.

### 3.3.3.2.3 Set Day/Night

The function is used to set the switch between color mode and black&white mode, which can effectively guarantee that the camera can still capture clear image even in the environment with low brightness.

The steps of setting day/night are as follows:

#### Step 1

Move the cursor to the “Day/Night Setting” and click “OK” to enter the third menu, which is shown in Figure 3-19.

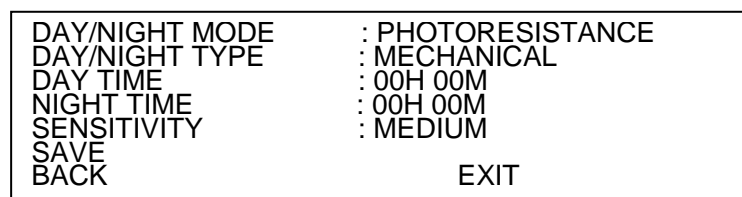

Figure 3-19

#### Step 2

Select day/night mode.

- Select “Auto”, “Night”, “Day”.

1. Click left and right button to select corresponding day/night mode.
  - ✧ Auto: It is to auto implement day/night switch according to the environment.
  - ✧ Night: Select night mode manually.
  - ✧ Day: Select day mode manually.

2. Move the cursor to the “Day/Night Type” and click left and right button to select switch type, which includes mechanical and electronic.
  - ✧ Mechanical: It is to realize day/night switch via optical filter.
  - ✧ Electronic: It is to realize day/night switch via image processing mode.
- Select “AUTO”.
  1. Click left and right button to select “Auto”.
  2. Move the cursor to the “Day/Night Type” and click left and right button to select switch type.
  3. Move the cursor to the “Sensitivity” and click left and right button to set sensitivity of day/night switch.
- Select “TIME”
  1. Click left and right button to select “Time”.
  2. Move the cursor to the “Day/Night Type” and click left and right button to select switch type.
  3. Move the cursor to the “Day Time” and click “OK” to set the enable time of day mode. Click up and down button to set exact value, click left and right button to select hour or minute.
  4. Click “OK” to exit the time setting of day time.
  5. Move the cursor to the “Night Time” and click “OK” to set the enable time of night mode. Click up and down button to set exact value, click left and right button to select hour or minute.
  6. Click “OK” to exit the time setting of Night mode.
  7. Click “Save” to save the settings.

#### 3.3.3.2.4 Focus Setting

The function is used to set the focus of the speed dome.

The steps of setting focus are shown as follows:

##### Step 1

Move the cursor to the “Image Adjust” and click “OK” to enter the third menu, which is shown in Figure 3-20.

FOCUS MODE : SEMI AUTO FOCUS LIMIT : 10CM SENSITIVITY : MEDIUM ZOOM TRACK : ON IR FOCUS ADJUST : OFF LASER FOCUS ADJUST : OFF BACK : EXIT
---

Figure 3-20

##### Step 2

Click left and right button to select focus mode.

You can select semi auto, auto and manual, please refer to the following sheet for more details.

Menu Item	Note
Semi auto	Focus once for the same scene, which can be applied to the scene with basically no change for the focusing target.
Auto	It will focus again if there is any change in the same scene, which can effectively guarantee the image definition, but it needs some time for each focus.
Manual	It needs to users to focus manually.

##### Step 3

Move the cursor to the “Focus Limit” and click left and right button to set the focus limit value of the speed dome. Focus limit means the min distance that the speed dome can focus, the speed dome will focus with limit value by priority when the “Focus Mode” is “Auto” or “Semi Auto”.

Step 4

Move the cursor to the “Focus Sensitivity” and click the left and right button to set the sensitivity.

Step 5

Move the cursor to the “Zoom Track”, click left and right button to select “On/Off”.

The speed dome can also focus to guarantee the image definition after enabling the function of zoom track.

Step 6

Move the cursor to the “IR/Laser Focus Adjust”, click left and right button to select “On/Off”.

### 3.3.3.2.5 Image Adjust

The function is mainly used to adjust the image hue, brightness and some other parameters.

The steps of adjusting image are as follows:

Step 1

Move the cursor to the “Image Adjust”, click “OK” to enter the third menu, which is shown in Figure 3-21.

HUE	: 50
BRIGHTNESS	: 50
SATURATION	: 50
CHROMA SUPPRESS	: 2
GAMMA	: 1
CONTRAST	: 50
STYLE	: STANDARD
BACK	EXIT

Figure 3-21

Step 2

Click UDLR button and “OK” button to adjust each parameter of the image.

Please refer to the following sheet for more details about each parameter.

Menu Item	Note
Hue	It is to set the image hue, the range is from 0 to 100, and the default is 50.
Brightness	It is to set the image brightness, the range is from 0 to 100, and the default is 50.
Saturation	It is to set the image saturation, the range is from 0 to 100, and the default is 50.
Chroma Suppress	It is to set the image color suppression, the range is from 1 to 16, and the default is 2.
Gamma	It is to set the image gamma, the range is from 1 to 16, and the default is 8.
Contrast	It is to set the image contrast, the range is from 0 to 100, and the default is 50.
Style	It is to set the image style, include standard, vivid and soft, it is standard by default.

### 3.3.3.2.6 Zoom Speed Setting

The function is used to set the zoom speed of the speed dome.

The steps of setting zoom speed are as follows:

Step 1

Move the cursor to the “Zoom Speed”.

Step 2

Click left and right button to set zoom speed.

---

### 3.3.3.2.7 Sharpness Setting

The function is used to set the sharpness of the speed dome, change the lens resolution and adjust the image definition.

The steps of setting sharpness are as follows:

Step 1

Move the cursor to the "Sharpness Setting".

Step 2

Click left and right button to set sharpness value.

### 3.3.3.2.8 Sharpness Suppress Level Setting

The function is used to set the sharpness suppress level to realize the result of suppressing sharpness.

The steps of setting sharpness suppress level are as follows:

Step 1

Move the cursor to the "Sharpness Suppress Level".

Step 2

Click left and right button to set the value of sharpness suppress level.

### 3.3.3.2.9 Digital Zoom Setting

The function is used to set if it is to enable the function of digital zoom.

The steps of setting digital zoom are as follows:

Step 1

Move the cursor to the "Digital Zoom".

Step 2

Click left and right button select "On/Off".

### 3.3.3.2.10 Digital Zoom Limit Setting

The function is used to set the limit of digital zoom.

The steps of setting digital zoom limit are as follows:

Step 1

Move the cursor to the "Digital Zoom Limit".

Step 2

Click left and right button to select the limit value of digital zoom,

### 3.3.3.2.11 Defog Setting

The function of defog setting can effectively improve the quality of monitoring image in the foggy and haze environment.

The steps of setting defog are as follows:

Step 1

Move the cursor to the "Defog Setting", click "OK" button to enter the third menu, which is shown in Figure 3-22.

DEFOG MODE	: OFF	
INTENSITY	: 1	
AIR INTENSITY MODE	: AUTO	
AIR INTENSITY VALUE	: 14	
BACK		EXIT

Figure 3-22



---

## Step 2

Select defog mode.

- Select “Off”

Click left and right button to select “OFF”.

The system will disable the defog function.

- Select “Auto”.

Click left and right button to select “Auto”.

The system can auto adjust the image according to the external environment.

- Select “Auto”.

1. Click left and right button to select “Manual”.

2. Move the cursor to the “Intensity”, click left and right button to set the defog intensity value.

3. Move the cursor to the “Air Intensity Mode”, click left and right button to select “Auto/Manual”.

When the deviation of auto recognition for fog is quite big (such as white wall), users can manually select suitable air light intensity value to improve the recognition rate of auto defog.

4. If it is to select “Manual” for “Air Intensity Mode”, then move the cursor to “Air Intensity Value”, click left and right button to set the value.

### **3.3.3.2.12 Image Flip Setting**

The function is used to flip the monitoring image.

The steps of setting image flip are as follows:

#### Step 1

Move the cursor to the “Image Flip”.

#### Step 2

Click left and right button to select “On/Off”.

### **3.3.3.2.13 Image Freeze Setting**

After the image is freezed, the screen will directly display the preset when calling preset, and there is no rotation during the process.

The steps of setting image freeze are as follows:

#### Step 1

Move the cursor to the “Image Freeze”.

#### Step 2

Click left and right button to select “On/Off”.

### **3.3.3.2.14 Image Dejitter Setting**

The function of image dejitter can effectively guarantee the image definition when there is slight vibration happening to the speed dome.

The steps of setting image dejitter are as follows:

#### Step 1

Move the cursor to the “Image Dejitter”.

#### Step 2

Click left and right button to select “On/Off”.

### **3.3.3.2.15 Image Output Mode Setting**

---

The function is used to set the image output mode, which mainly includes 1080P/30f, 1080P/25f, 720P/25f, 720P/30f, 720P/50f, 720P/60f, the back-end devices need to support corresponding image mode to collect image.

The steps of setting image output mode are as follows:

Step 1

Move the cursor to the “Image Output Mode”.

Step 2

Click left and right button to select the video format which needs to be output.

#### 3.3.3.2.16 Camera Default Setting

The function is used to reset all the settings in ‘3.3.3 Camera Setting’.

The steps of camera default setting are as follows:

Step 1

Move the cursor to the “Camera Default”.

Step 2

Click “OK” to make the setting valid.

#### 3.3.3.2.17 Camera Restart

The function is used to restart the camera; some functions can be valid after restarting the camera.

The steps of restarting the camera are as follows:

Step 1

Move the cursor to the “Camera Restart”.

Step 2

Click “OK” to make the setting valid.

### 3.3.4 Function Setting

Move the cursor to the “Function Setting”, click “OK” to enter the second menu, which is shown in Figure 3-23.

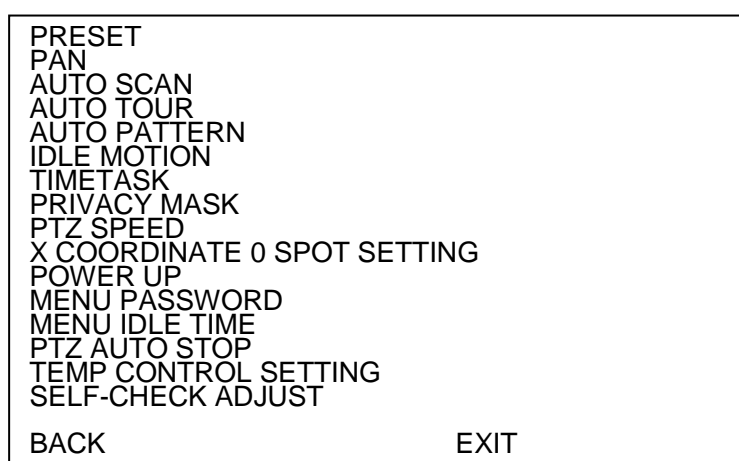

Figure 3-23

#### 3.3.4.1 Preset Setting

Preset means the environment that the camera is located, users can quickly adjust the PTZ and camera to the environment via calling preset.

---

The steps of setting preset are as follows:

Step 1

Move the cursor to the “Preset”, click “OK” to enter the third menu, which is shown in Figure 3-24.

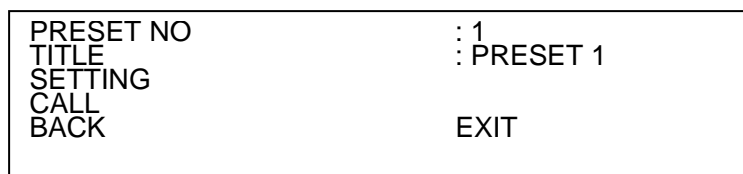

Figure 3-24

Step 2

Click left and right button to set the preset number and title.

**Note:**

As for the preset name, the system will auto sync the name according to the preset number; for example, if you set preset number as “1”, then the preset name will automatically be “Preset 1”.

Step 3

Control the speed dome and move the image which needs to be monitored.

Step 4

Move the cursor to the “Setting” and click “OK”.

It will display “Ok” and then disappear on the menu, which means that the users have successfully set a preset.

Note:

- If the menu “Display Setting > Preset Title” is set as on, then it will display “Preset: XXX” on the screen, XXX means the preset number which has been set.
- If users need to modify the original preset, he or she just directly modify the “Preset No.” and monitoring spot, move the cursor to the “Setting” to reconfirm to cover the record info of the original preset.

Step 5

Call preset.

1. Move the cursor to the “Preset No” and select the preset number which needs to be called.
2. Move the cursor to the “Call” and click “Ok”, and then the system can call the preset.

**Note:**

**For PELCO protocol user, please refer to the following special functions:**

- **Call preset:** Call preset 28 or preset 95 to go to dome menu. Call preset 29 or preset 99 to go to scan. Call preset 24 or preset 81 to go to pattern. Call preset 25 or preset 82 to go to tour. Call preset 30 or preset 96 to stop scan or pattern. Call preset 31 or preset 83 to begin rotation. Call preset 33 to enable PTZ 180 degrees rotation. Call preset 34 to set dome position as 0.
- **Set preset:** Set preset 26 or 92 to set scan left limit. Set preset 27 or 93 to set scan right limit. Set preset 22 or 79 to begin record. Set preset 23 or 80 to stop record.

### 3.3.4.2 Pan Rotation Setting

Pan rotation means the intelligent speed dome rotates continuously 360° horizontally with a certain speed.

The steps of setting horizontal rotation are as follows:

Step 1

Move the cursor to the “Pan”, click “OK” to enter the third menu, which is shown in Figure 3-25.



Figure 3-25

Step 2

Click left and right button to set the speed of horizontal rotation.

Step 3

Move the cursor to the “Call” and click “OK”, the speed dome will begin to implement 360° continuous rotation horizontally. Move the cursor to “Stop” and click “OK” to stop horizontal rotation of the speed dome.

### 3.3.4.3 Auto Scan Setting

Auto scan means the speed dome scanning back and forth with a certain speed within a certain range to display image horizontally. After setting the left and right limit and scanning speed, the speed dome will scan back and forth within the range which has been set with a certain speed.

The steps of setting auto scan are as follows:

Step 1

Move the cursor to the “Auto Scan”, click “OK” to enter the third menu, which is shown in Figure 3-26.

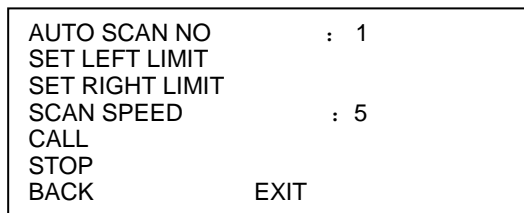

Figure 3-26

Step 2

Click left and right button to set scan number.

Step 3

Control the speed dome and move to the left limit of the needed scan range.

Step 4

Move the cursor to “Set Left Limit” and click “OK”. Then the left limit of auto scan has been set.

Step 5

Control the speed dome and move to the right limit of the needed scan range.

Step 6

Move the cursor to the “Set Right Limit” and click “Ok”. Then the right limit of auto scan has been set.

Step 7

Move the cursor to “Scan Speed”, click left and right button to select scan speed.

Step 8

Call scan.

1. Move the cursor to the “Scan No’ and select the scan number which needs to be called.
2. Move the cursor to “Call” and click “Ok”, and then the system can call the scan. Move the cursor to “Stop” and click “Ok”, and then the system will stop calling the scan.

### 3.3.4.4 Auto Tour Setting

Auto tour means that it can arrange some presets into the line of auto tour with the needed sequence by setting in advance, the users can make the speed dome auto move back and forth with certain interval according to the preset sequence which has been set already.

The steps of setting auto tour are as follows:

**Step 1**

Move the cursor to "Auto Tour", click "Ok" to enter the third menu, which is shown in Figure 3-27.

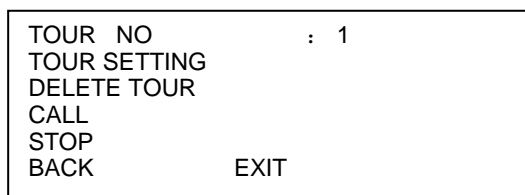

Figure 3-27

**Step 2**

Click left and right button to set tour No.

**Step 3**

Move the cursor to "Setting", click "OK" to enter fourth menu to make tour setting, which is shown in Figure 3-28.

NO	PRESET	DWELL	SPEED
01	000	005	013
02	000	005	013
03	000	005	013
...	...	...	...
32	000	005	013
	BACK		EXIT

Figure 3-28

**Step 4**

Set the preset number, dwell time and call speed, and then click "OK" to exit corresponding setting.

**Step 5**

Call auto tour.

1. Move the cursor to the "Tour No" and select the tour number which needs to be called.
2. Move the cursor to the "Call" and click "OK", the system will call the tour course. Move the cursor to "Stop" and click "OK", the system will stop calling the tour course.

### 3.3.4.5 Auto Pattern Setting

Auto pattern can continuously record the manual operations upon the PTZ and zoom in and out over the speed dome focal length and other movement traces implemented by users, set the recording spot as a beginning point, then the speed dome can move back and forth according to the movement trace which has been set.

The steps of setting auto pattern are as follows:

**Step 1**

Move the cursor to "Auto Pattern", click "OK" to enter the third menu, which is shown in Figure 3-29.

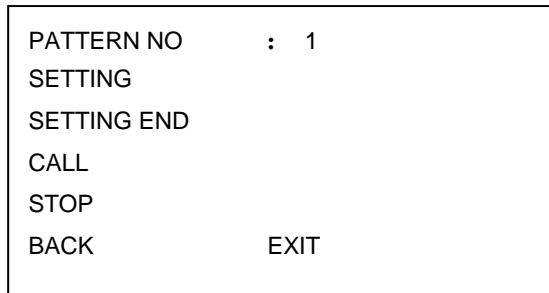

Figure 3-29

Step 2

Click left and right button to set pattern number.

Step 3

Move the cursor to “Setting” and click “OK”, the screen will display “OK”, the system will begin to set pattern course.

Step 4

After operating the speed dome according to the needs of the users, move the cursor to the “Setting End” and click “OK”, the screen will display “OK”, and then the system will finish setting the pattern course.

**Note:**

When the dwell time of two orders is over 1 minute, then the system will take 1 minute by default automatically.

Step 5 Call Auto Pattern

1. Move the cursor to “Pattern No” and select the pattern number which needs to be called.
2. Move the cursor to “Call” and click “OK”, then the system can call the pattern course. Move the cursor to ‘Stop” and click “OK”, the system can stop calling the pattern course.

**Note:**

After clicking “Setting End”, it needs to wait till the “●” icon disappears, then click “Call”. Any manual PTZ operation during pattern will make the speed dome stop pattern.

### 3.3.4.6 Idle Motion Setting

Idle motion means that the speed dome will implement the motion set in advance if it fails to receive any valid commands during the period that has been set.

The steps of setting idle motion are as follows:

Step 1

Move the cursor to “Idle Motion”, click “OK” to enter the third menu, which is shown in Figure 3-30.

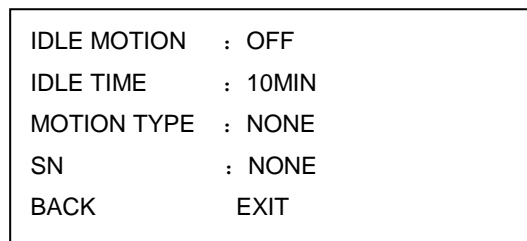

Figure 3-30

Step 2

Move the cursor to “Idle Motion” and click left and right button to set it as “ON”.

Step 3

---

Move the cursor to “Idle Time” and click left and right button to set the proper time.

Step 4

Move the cursor to “Motion Type” and click left and right button to set motion type, users can select “None/Preset/Scan/Tour/Pattern”.

Step 5

Move the cursor to “SN” and click left and right button to set the serial number of corresponding motion.

### 3.3.4.7 Time Task Setting

Time task means implementing relevant motions during the period which has been set.

The steps of setting time task are as follows:

Step 1

Move the cursor to “Time Task”, click “OK” to enter the third menu, which is shown in Figure 3-31.

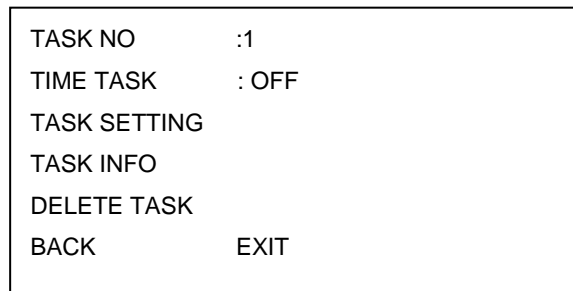

Figure 3-31

Step 2

Click left and right button to set task number.

Step 3

Move the cursor to “Task Setting”, click “OK” to enter the fourth menu, which is shown in Figure 3-32.

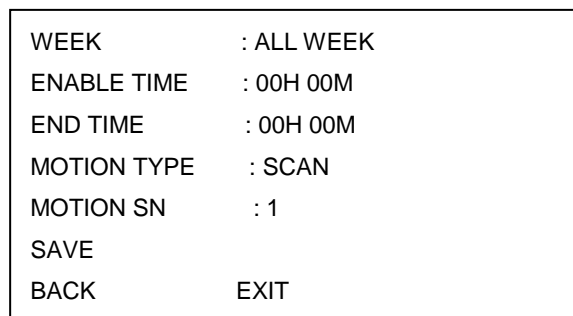

Figure 3-32

Step 4

Click the UDLR buttons to set the parameters of “Week”, “Enable Time”, “End Time”, “Motion Type”, “Motion SN” etc.

Step 5

Click “Save” to save the settings and exit the setting interface.

After the setting is completed, “Time Task” will turn into enable status automatically.

Move the cursor to “Task Info” and click “OK” to check the task which has been set, which is shown in Figure 3-33.

SN	TIME	MOTION
1	ALL WEEK 01:00-02:00	SCAN 001

Figure 3-33

Move the cursor to “Delete Task” and click “OK” to delete the time task.

### 3.3.4.8 Privacy Mask Setting

Privacy mask means setting a certain masked area to protect privacy in the monitoring area.

The steps of setting privacy mask are as follows:

Step 1

Move the cursor to “Privacy Mask”, click “OK” to enter the third menu, which is shown in Figure 3-34.

PRIVACY MASK NO:	:1
PRIVACY MASK SETTING	: OFF
BACK	EXIT

Figure 3-34

Step 2

Click left and right button to set the number of privacy mask.

**Note:**

Different models are equipped with different modules, then the quantity of privacy mask and exact requirements of setting are different.

Step 3

Move the cursor to “Setting”, click “OK” to enter the fourth menu, which is shown in Figure 3-35.

SIZE	: →
SAVE	
BACK	EXIT

Figure 3-35

Step 4

At this moment a privacy area is displayed in the center of the screen, it needs to make the center of the masked object match the center of the screen via moving speed dome screen by operating PTZ.

Step 5

Set the size of the masked privacy area.

1. Move the cursor to “Size”, click left and right button to select the change mode of the masked privacy area. “←” means becoming narrower horizontally, “→” means becoming wider horizontally, “↑” means becoming higher vertically, “↓” means becoming shorter vertically.
2. Click “OK” continuously to adjust the needed size.

**Note:**

Try to make the setting area bigger than the area which is needed to mask the object during setting, otherwise, it is possible for the masked object to expose during movement.

Step 6

Click “Save” to save the settings and exit the setting interface.

After setting, the “Privacy Mask” will become enable status automatically.



---

As for the privacy mask area which has been set, move the cursor to “Privacy Mask No”, click left and right button to select privacy mask number and click “OK” , the image will be switched into the privacy protection area which has been set.

#### 3.3.4.9 PTZ Speed Setting

PTZ speed means the rotation speed of the PTZ.

The steps of setting PTZ speed are as follows:

Step 1

Move the cursor to “PTZ Speed”.

Step 2

Click left and right button to select PTZ speed, you can select 1/2/3 three levels.

#### 3.3.4.10 Set Horizontal Coordinate 0 Spot

It means the location where the speed dome stays after self check, users can set the location at random according to the actual situation.

The steps of setting horizontal coordinate 0 spot are as follows:

Step 1

Move the cursor to “Horizontal Coordinate 0 Spot”.

Step 2

Control the speed dome and move it to the needed location which is set as the horizontal coordinate 0 spot.

Step 3

Click “OK”, the screen displays “OK” to show that the setting is valid.

#### 3.3.4.11 Power up Setting

It means the motion which is automatically operated after powering up the speed dome.

The steps of power up are shown as follows:

Step 1

Move the cursor to “Power Up”, click “OK” to enter the third menu, which is shown in Figure 3-36.

POWER UP	: AUTO
SN	: NONE
BACK	EXIT

Figure 3-36

Step 2

Click left and right button to select the motion type of power up, users can select “Auto/Preset/Scan/Tour/Pattern/None”. The system will operate the last motion before power off when selecting “Auto”.

Step 3

Move the cursor to “SN”, click left and right button to select the serial number of corresponding motion.

#### Note:

It firstly needs to set preset location, scan course, tour course, pattern course etc. if the users need to set the motion of power up as “preset”, “scan”, “tour” and “pattern”. Otherwise, the speed dome will not generate any motions even if it has set the power up motion and serial number.

#### 3.3.4.12 Menu Password Setting

---

The function is used to set the menu password, it needs to enter correct password when users opening the menu, otherwise, it will fail to open the menu.

**Note:**

The menu will be locked after the users entering wrong password for three times.

The steps of setting menu password are as follows:

Step 1

Move the cursor to “Power Up”, click “OK” to enter the third menu, which is shown in Figure 3-37.

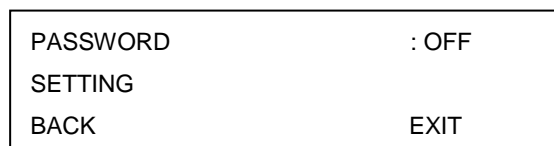

Figure 3-37

Step 2

Move the cursor to “Setting”, click “OK” to enter the fourth menu, which is shown in Figure 3-38.



Figure 3-38

Step 3

Move the cursor in front of some certain number, click “OK” to generate a password. Click “←” to delete the number which has been input.

**Note:**

The password can be set with max 8 numbers.

Step 4

Click “OK”, enter the password again according to the system requirement.

Step 5

Click “OK” to complete setting and exit the setup interface. The “Password” will automatically change into the enable status after finishing settings.

### 3.3.4.13 Menu Idle Time Setting

When the menu is opened and the setting is not “Off”, it will auto exit the menu if there isn't any operations upon the menu during the period which has been set.

The steps of setting menu idle time are as follows:

Step 1

Move the cursor to “Menu Idle Time”.

Step 2

Click left and right button to select the time which needs to be set.

### 3.3.4.14 PTZ Auto Stop Setting

PTZ auto stop means that the speed dome will auto stop relevant PTZ motions when it meets the interval which has been set if it fails to receive any control commands over the speed dome.

The steps of setting PTZ auto stop are as follows:

---

Step 1

Move the cursor to "PTZ Auto Stop".

Step 2

Click left and right button to select the time which needs to be set.

### 3.3.4.15 Temp Control Setting

The function is used to set the heater of speed dome.

The steps of setting temperature control are as follows:

Step 1

Move the cursor to "Temp Control", click "OK" to enter the third menu, which is shown in Figure 3-39.

TEMP CONTROL	: AUTO
TEMP ON	: 03
TEMP OFF	: 12
BACK	EXIT

Figure 3-39

Step 2

Click left and right button to set "Temp Control" as "Auto".

Step 3

Move the cursor to "Temp On", click left and right button to set the temperature value. It will auto enable the heater when the temperature is lower than the value.

Step 4

Move the cursor to "Temp Off", click left and right button to set the temperature value. It will auto disable the heater when the temperature is higher than the value.

### 3.3.4.16 Self-check Adjust Setting

It can adjust the vertical location of the PTZ via enabling self-check adjust function.

The steps of setting self-check adjust are as follows:

Step 1

Move the cursor to "Self-Check Adjust".

Step 2

Click left and right button to select "On/Off".

#### Note

The function can be valid only after rebooting the device

### 3.3.4.17 Channel Title Setting

It is to set the content of channel title and the location of monitoring image.

The steps of setting channel title are shown as follows:

Step 1

Move cursor to "Channel Title", click "OK" to enter the third menu, which is shown in Figure 3-40.

TITLE LOCATION	:UPPER LEFT
SETTING	
BACK	EXIT

Figure 3-40

---

Step 2

Click left and right button and set “Title Location” as “Upper Left” or “Lower Right”.

Step 3

Move the cursor to “Setting”, click “OK” to enter fourth menu, which is shown in Figure 3-41.

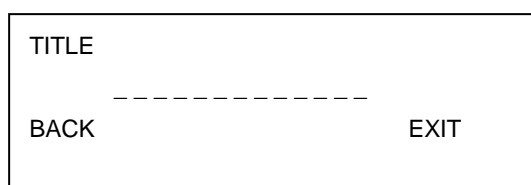

Figure 3-41

Step 4

Click up and down button to set content of channel title; click left and right button, move the cursor to the next digit of the channel title.

**Note**

The channel title can be made up of numbers and letters, the range of numbers is from 0 to 9 and the range of letters is from A to Z.

Step 5

Click “OK” to complete setting.

### 3.3.5 Alarm Setting

The function is used to set the alarm of the speed dome.

The steps of setting alarm are as follows:

Step 1

Move the cursor to “Alarm Setting”, click “OK” to enter the second menu, which is shown in Figure 3-42.

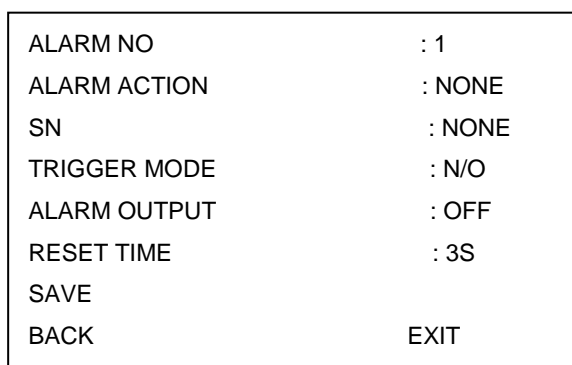

Figure 3-42

Step 2

Click left and right button to select the channel number of alarm input.

Step 3

Move the cursor to “Alarm Action”, click left and right button to select alarm linkage action, users can set “None/Preset/Scan/Tour” and several other alarm actions.

Step 4

Move the cursor to “SN”, click left and right button to select the SN of the corresponding alarm action.

Step 5

Move the cursor to “Trigger Mode”, click left and right button to select the trigger mode of alarm action.

- N/O: Normally open, it won't trigger alarm when the alarm input cable and ground cable are disconnected by default, it can only trigger alarm when it is closed.

- N/C: Normally closed, it will trigger alarm when the alarm input cable and ground cable are disconnected, it won't trigger alarm when it is closed.

#### Step 6

Move the cursor to "Alarm Output", click left and right button to select alarm output mode.

The relay alarm linkage output select off/1→5s, 1 means the number one alarm relay, 5s means relay auto reset after alarm signal disappears for 5 seconds.

#### Step 7

Move the cursor to "Save" and click "OK", it displays "OK" on the screen and it means saving setting successfully.

### 3.3.6 Wiper Setting

The function can be used to set the wiper of speed dome.

The steps of setting wiper are as follows:

#### Step 1

Move the cursor to "Wiper Setting", click "OK" to enter the second menu, which is shown in Figure 3-43.

WIPER MODE	: MANUAL
ENABLE TIME	: 07H 00M
STOP TIME	: 19H 00M
INTERVAL	: 01S
WIPER CONTROL	: STOP
SAVE	
BACK	EXIT

Figure 3-43

#### Step 2

Click left and right button to select wiper mode.

- If "Wiper Mode" is set as "Manual".
  1. Move the cursor to "Interval", click left and right button to set the interval between twice wiper action
  2. Move the cursor to "Wiper Control", click left and right button to select the operation mode of the wiper, you can select "Once/Enable/Stop".
- If the "Wiper Mode" is set as "Auto".
  1. Move the cursor to "Enable Time", click left and right button to set the enable time of auto operation for the wiper.
  2. Move the cursor to "Stop Time", click left and right button to set the stop time of auto operation for the wiper.
  3. Move the cursor to "Interval", click the left and right button to set the interval of twice wiper action.
  4. Click "Save" to save the settings.

### 3.3.7 IR Light Setting

The function is used to set IR light of the speed dome.

The steps of setting IR light are as follows:

---

Step 1

Move the cursor to “IR Light Setting”, click “OK” to enter the second menu, which is shown in Figure 3-44.

IR SENSITIVITY	: 04
IR CONTROL	: ZOOM PRIO
NEAR LIGHT	: 50
FAR LIGHT	: 50
IR LIGHT COMP	: 03
BACK	EXIT

Figure 3-44

Step 2

Click left and right button to select IR light sensitivity.

Step 3

Select IR control mode.

- Select “Zoom Prio”.
  1. Click left and right button to select “Zoom Prio”. The speed dome can auto adjust IR light brightness according to the actual zoom rate.
  2. Move the cursor to “IR Light Comp”, click left and right button to set the IR light compensation value.
- Select “Manual”.
  1. Click left and right button to select “Manual”.
  2. Move the cursor to “Near Light”, click left and right button to set the brightness value of near light.
  3. Move the cursor to “Far Light”, click left and right button to set the brightness value of far light.

### 3.3.8 White Light Setting

The function is used to set the white light of speed dome.

The steps of setting white light are as follows:

Step 1

Move the cursor to “White Light Setting”, click “Ok” to enter the second menu, which is shown in Figure 3-45.

WHITE LIGHT SENSITIVITY	: 04
WHITE LIGHT CONTROL RULE	: ZOOM PRIO
NEAR LIGHT	: 50
FAR LIGHT	: 50
WHITE LIGHT COMP	: 03
BACK	EXIT

Figure 3-45

Step 2

Click left and right button to select white light sensitivity.

Step 3

Select the control mode of white light.

- Select “Zoom Prio”.
  1. Click left and right button to select “Zoom Prio”. The speed dome can auto adjust the brightness of white light according to the actual zoom rate.

---

2. Move the cursor to “White Light Comp”, click left and right button to set the white light compensation value.

- Select “Manual”.

1. Click left and right button to select “Manual”.

2. Move the cursor to “Near Light”, click left and right button to set the brightness value of near light.

3. Move the cursor to “Far Light”, click left and right button to set the brightness value of far light.

### 3.3.9 Laser Setting

The function is used to set the laser light of speed dome.

The steps of setting laser light are as follows:

Step 1

Move the cursor to “Laser Setting”, click “OK” to enter the second menu, which is shown in Figure 3-46.

LASER CONTROL RULE	: MANUAL
ANGLE	: 7
INTENSITY	: OFF
BACK	EXIT

Figure 3-46

Step 2

Select laser control rule.

- Select “Zoom Prio”.

Click left and right button to select “Zoom Prio”.

The speed dome can auto adjust the angle and intensity of laser light according to the actual zoom rate.

- Select “Manual”.

1. Click left and right button to select “Manual”.

2. Move the cursor to “Angle”, click left and right button to set the angle of the laser light.

3. Move the cursor to “Intensity”, click left and right button to set the intensity of the laser light.

---

## 4 System Connection

### 4.1 System Diagram

Please refer to Figure 4-1 for the bus connection.

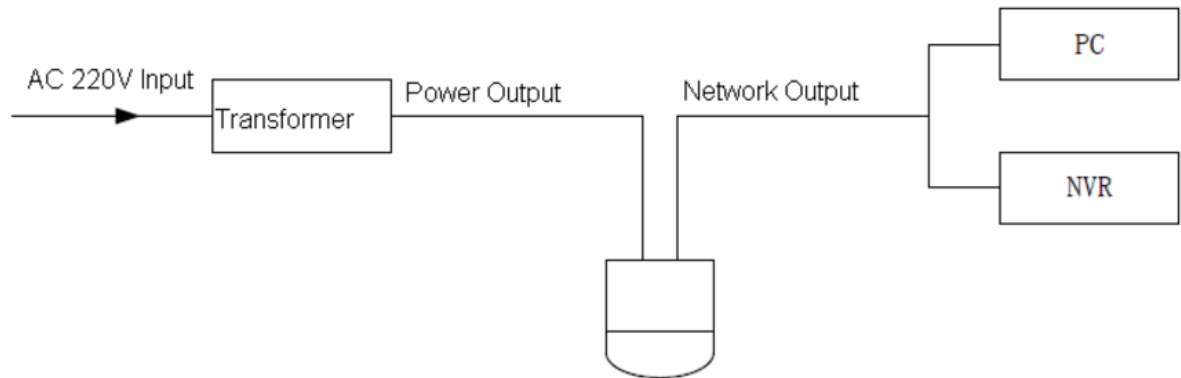

Figure 4-1

### 4.2 Alarm Connection

Please refer to Figure 4-2 for alarm connection.

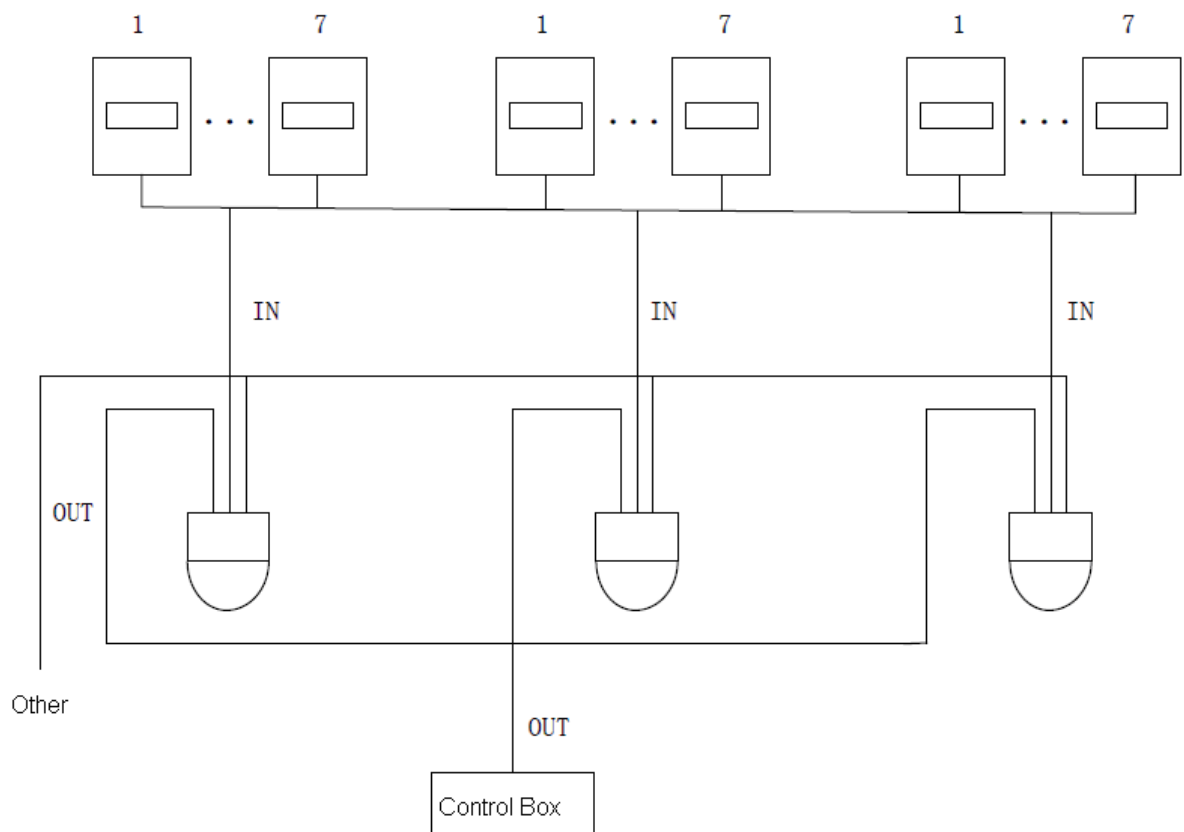

Figure 4-2



## 5 Daily Maintenance

### 5.1 Regular Cleaning

Please clean dome cover regularly to get vivid image.

Handle the cover with care. Use water to wash. Don't use cloth to clean.

Use mild detergent to clean if there is too much dust.

**Note:**

The sweat from your hand may erode plating surface, your nail may scrape dome cover result in blur image.

### 5.2 Problems and Solutions

SYMPTOM	CAUSE	SOLUTION
1) No self-diagnosis, no video signal when I connect dome to power.	Red LED is not on. <ul style="list-style-type: none"> <li>● Your power supplying does not apply to the power. Or connection is too loose.</li> <li>● Power off or transformer problem.</li> </ul>	<ul style="list-style-type: none"> <li>● Check power is connected or properly earthed.</li> <li>● Check power supply condition or check transformer.</li> </ul>
	Red LED light on the power board is on <ul style="list-style-type: none"> <li>● Power supplying is low</li> <li>● Something wrong with power board.</li> </ul>	<ul style="list-style-type: none"> <li>● Use multimeter to check dome load.</li> <li>● Please contact retailer to replace power board.</li> </ul>
2) No self-diagnosis. There is a noise	Power supplying is inadequate.	Replace power supplying.
	Mechanical malfunction.	Need electrical engineer help.
3) Video signal loss occurs in high speed rotation.	Power supplying is not sufficient	Replace power supplying.
4) Video signal is not successive	Circuit connection is too loose.	Connect tightly.
	Video switch or power problem	Need electrical engineer help.
5) Video is not clear.	Focus is in manual mode.	Control manually.
	Dome cover is dirty.	Wash dome cover
6) During camera switch, there is a tilt movement in the monitor.	Camera power is not in the same Phase.	When several domes are connected to one transformer, please connect the transformer output cable to the domes' same side.

## 6 APPENDIX I LIGHTNING PROOF AND SURGE PROTECTION

This series speed dome adopts TVS lightning protection technology. It can effectively prevent damages from various pulse signals below 6000V, such as sudden lightning and surge. While maintaining your local electrical safety code, you still need to take necessary precaution measures when installing the speed dome in the outdoor environment.

- The distance between the signal transmission cable and high-voltage device (or high-voltage cable) shall be at least 50 meters.
- Outdoor cable layout shall go under the penthouse if possible.
- For vast land, please use sealing steel tube under the land to implement cable layout and connects one point to the earth. Open floor cable layout is forbidden.
- In area of strong thunderstorm hit or near high sensitive voltage (such as near high-voltage transformer substation), you need to install additional high-power thunder protection device or lightning rod.
- The thunder protection and earth of the outdoor device and cable shall be considered in the building whole thunder protection and conform to your local national or industry standard.
- System shall adopt equal-potential wiring. The earth device shall meet anti-jamming and at the same time conforms to your local electrical safety code. The earth device shall not short circuit to N (neutral) line of high voltage power grid or mixed with other wires. When connect the system to the earth alone, the earth resistance shall not be more than  $4\Omega$  and earth cable cross-sectional area shall be below  $25\text{ mm}^2$ . See Figure 6-1.

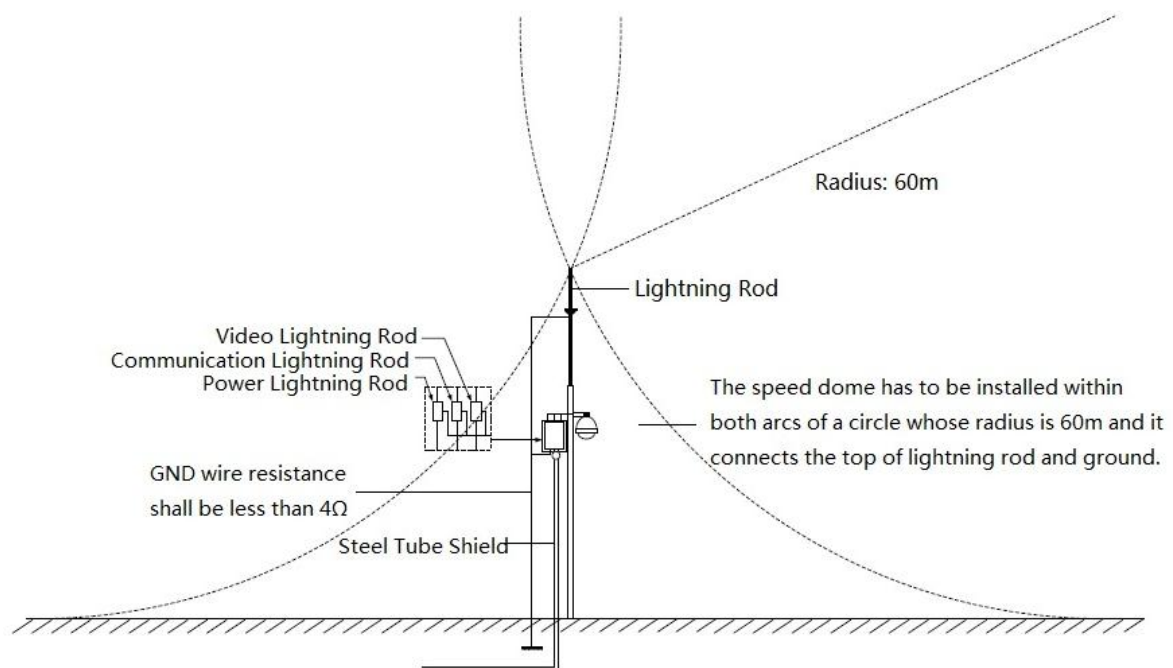

Figure 6-1

---

**Note**

- **This manual is for reference only. Slight difference may be found in the user interface.**
- **All the designs and software here are subject to change without prior written notice.**
- **All trademarks and registered trademarks mentioned are the properties of their respective owners.**
- **If there is any uncertainty or controversy, please refer to the final explanation of us.**
- **Please visit our website or contact your local service engineer for more information.**